











**UNION PANAMERICANA DE JUDO
FEDERACION DOMINICANA DE JUDO**



Evento **VIII CIRCUITO INTERNACIONAL INFANTIL Y JUVENIL 2004**
 Lugar **Casa Nacional del Judo, Sto. Dgo. Rep. Dom.** Fecha **24/07/2004** al **24/07/2004**
 Place

Cuadro por Puntos/ Table Results by Points

Categoría
Category **Junior General**

Posición Position	País Country	Oro 1st	Plata 2nd	Bronce 3rd	Quinto 5th	Séptimo 7th	Total Puntos Sumary Points
1	DOM 	4	5	13	11	0	192
2	PUR 	3	2	5	1	0	89
3	MEX 	3	1	2	0	0	55
4	VEN 	4	0	1	0	0	49
5	HAI 	0	1	2	3	0	25
6	COL 	1	2	0	0	0	24
7	ECU 	1	2	0	0	0	24
8	TRI 	0	0	0	0	0	0
Total		16	13	23	15	0	











UNION PANAMERICANA DE JUDO
FEDERACION DOMINICANA DE JUDO



Evento **VIII CIRCUITO INTERNACIONAL INFANTIL Y JUVENIL 2004**
 Lugar **Casa Nacional del Judo, Sto. Dgo. Rep. Dom.** Fecha **24/07/2004** al **24/07/2004**
 Place

Cuadro por Puntos/ Table Results by Points

Categoría
Category **Junior Masc**

Posición Position	País Country	Oro 1st	Plata 2nd	Bronce 3rd	Quinto 5th	Séptimo 7th	Total Puntos Sumary Points
1	DOM 	3	4	8	7	0	130
2	PUR 	3	0	3	0	0	57
3	MEX 	0	1	1	0	0	16
4	ECU 	1	0	0	0	0	10
5	VEN 	1	0	0	0	0	10
6	COL 	0	1	0	0	0	7
7	HAI 	0	0	0	1	0	0
8	TRI 	0	0	0	0	0	0
Total		8	6	12	8	0	









**UNION PANAMERICANA DE JUDO
FEDERACION DOMINICANA DE JUDO**



Evento **VIII CIRCUITO INTERNACIONAL INFANTIL Y JUVENIL 2004**
 Lugar **Casa Nacional del Judo, Sto. Dgo. Rep. Dom.** Fecha **24/07/2004** al **24/07/2004**
 Place

Cuadro por Puntos/ Table Results by Points

Categoría
Category **Junior Fem**

Posición Position	País Country	Oro 1st	Plata 2nd	Bronce 3rd	Quinto 5th	Séptimo 7th	Total Puntos Sumary Points
1	DOM 	1	1	5	4	0	62
2	MEX 	3	0	1	0	0	39
3	VEN 	3	0	1	0	0	39
4	PUR 	0	2	2	1	0	32
5	HAI 	0	1	2	2	0	25
6	COL 	1	1	0	0	0	17
7	ECU 	0	2	0	0	0	14
Total		8	7	11	7	0	



**UNION PANAMERICANA DE JUDO
FEDERACION DOMINICANA DE JUDO**



Evento **VIII CIRCUITO INTERNACIONAL INFANTIL Y JUVENIL 2004**
Event

Lugar **Casa Nacional del Judo, Sto. Dgo. Rep. Dom.** **Fecha** **24/07/2004** **al**
Place **Date** **to** **24/07/2004**

Categoría **Junior** **Peso** **+100** **kgs.** **Sexo** **Masculino**
Category **Weight** **Gender**

Eliminatoria Round Robin (Todos contra todos)

Nº	Nombre	País	1	2	3	4	5	Vict.	Ptos.	Lugar
1	GARCIA Harold	PUR	■							1
2	--			■						
3	--	-			■					
4	--	-				■				
5	--	-					■			

Pool de: _____

Orden de los Combates		
1-2	1-2	1-2
2-3	3-4	3-4
1-3	1-3	1-5
	2-4	2-3
	1-4	4-5
	2-3	1-3
		2-5
		1-4
		3-5
		2-4

1º _____ (PUR)
 2º _____ ()
 3º _____ ()
 3º _____ ()
 5º _____ ()

Símbolo	Marcación	Puntos	Equivale	Inmovilización
○	IPPON	10	HANSOKU MAKE	25 seg.
⊖	WAZARI	7	3er SHIDO	de 20 a -25 seg.
⊗	YUKO	5	2do SHIDO	de 15 a -20 seg.
⊕	KOKA	3	1er SHIDO	de 10 a -15 seg.
⊗	HANTEI	1		



UNION PANAMERICANA DE JUDO
FEDERACION DOMINICANA DE JUDO



Evento **VIII CIRCUITO INTERNACIONAL INFANTIL Y JUVENIL 2004**
Event

Lugar **Casa Nacional del Judo, Sto. Dgo. Rep. Dom.** **Fecha** **24/07/2004** **al**
Place **Date** **to** **24/07/2004**

Categoría **Junior** **Peso** **-100** **kgs.** **Sexo** **Masculino**
Category **Weight** **Gender**

Eliminatoria Round Robin (Todos contra todos)

Nº	Nombre	País	1	2	3	4	5	Vict.	Ptos.	Lugar
1	DIAZ Edgardo	PUR	■							1
2	--			■						
3	--	-			■					
4	--	-				■				
5	--	-					■			

Pool de: _____

Orden de los Combates		
1-2	1-2	1-2
2-3	3-4	3-4
1-3	1-3	1-5
	2-4	2-3
	1-4	4-5
	2-3	1-3
		2-5
		1-4
		3-5
		2-4

1º _____ (PUR)
 2º _____ ()
 3º _____ ()
 3º _____ ()
 5º _____ ()

Símbolo	Marcación	Puntos	Equivale	Inmovilización
○	IPPON	10	HANSOKU MAKE	25 seg.
⊖	WAZARI	7	3er SHIDO	de 20 a -25 seg.
⊗	YUKO	5	2do SHIDO	de 15 a -20 seg.
⊕	KOKA	3	1er SHIDO	de 10 a -15 seg.
⊗	HANTEI	1		



UNION PANAMERICANA DE JUDO
FEDERACION DOMINICANA DE JUDO



Evento **VIII CIRCUITO INTERNACIONAL INFANTIL Y JUVENIL 2004**
Event

Lugar **Casa Nacional del Judo, Sto. Dgo. Rep. Dom.** Fecha **24/07/2004** al **24/07/2004**
Place Date to

Categoría **Junior** Peso **-90** kgs. Sexo **Masculino**
Category Weight Gender

Eliminatoria Round Robin (Todos contra todos)

Nº	Nombre Name	País Country	1	2	3	4	5	V	Ptos.	Lugar Place
1	RODRIGUEZ Angel	PUR	■							
2	DIEK Teofilo	DOM		■						
3	JESURUM Julio	DOM			■					
4	CONTRERAS Hamlet	DOM				■				
5	--	-					■			

Pool de: _____

Orden de los Combates		
1-2	1-2	1-2
2-3	3-4	3-4
1-3	1-3	1-5
	2-4	2-3
	1-4	4-5
	2-3	1-3
		2-5
		1-4
		3-5
		2-4

1º _____ ()
 2º _____ ()
 3º _____ ()
 3º _____ ()
 5º _____ ()

Símbolo	Marcación	Puntos	Equivale	Inmovilización
	IPPON	10	HANSOKU MAKE	25 seg.
	WAZARI	7	3er SHIDO	de 20 a -25 seg.
	YUKO	5	2do SHIDO	de 15 a -20 seg.
	KOKA	3	1er SHIDO	de 10 a -15 seg.
	HANTEI	1		

Tiempo Estimado min
 Pronostic Time
 Total Combates
 Combats Total

Director de Arbitraje
Referee Director

Director Deportivo
Sporting Director



**UNION PANAMERICANA DE JUDO
FEDERACION DOMINICANA DE JUDO**



Evento **VIII CIRCUITO INTERNACIONAL INFANTIL Y JUVENIL 2004**
Event

Lugar **Casa Nacional del Judo, Sto. Dgo. Rep. Dom.** **Fecha** **24/07/2004** **al**
Place **Date** **to** **24/07/2004**

Categoría **Junior** **Peso** **-81** **kgs.** **Sexo** **Masculino**
Category **Weight** **Gender**

Eliminatoria Round Robin (Todos contra todos)

Nº	Nombre	País	1	2	3	4	5	Vict.	Ptos.	Lugar
1	SCHOOT Ludwing	DOM	█	0	10	0		1	10	3
2	CHICLANA Alexis	PUR	10	█	10	10		3	30	1
3	CASANOVA Jaime	DOM	0	0	█	0		0	0	3
4	FIGUEROO Pedro	DOM	10	0	10	█		2	20	2
5	--	-					█			

Pool de: _____

Orden de los Combates		
1-2	1-2	1-2
2-3	3-4	3-4
1-3	1-3	1-5
	2-4	2-3
	1-4	4-5
	2-3	1-3
		2-5
		1-4
		3-5
		2-4

1º	CHICLANA Alexis	(PUR)
2º	FIGUEROO Pedro	(DOM)
3º	SCHOOT Ludwing	(DOM)
3º	CASANOVA Jaime	(DOM)
5º		()

Símbolo	Marcación	Puntos	Equivale	Inmovilización
○	IPPON	10	HANSOKU MAKE	25 seg.
◐	WAZARI	7	3er SHIDO	de 20 a -25 seg.
◑	YUKO	5	2do SHIDO	de 15 a -20 seg.
◒	KOKA	3	1er SHIDO	de 10 a -15 seg.
⊗	HANTEI	1		



UNION PANAMERICANA DE JUDO

FEDERACION DOMINICANA DE JUDO



Evento
Event
Lugar
Place

VIII CIRCUITO INTERNACIONAL INFANTIL Y JUVENIL 2004

Casa Nacional del Judo, Sto. Dgo. Rep. Dom.

Fecha
Date

24/07/2004

al
to

24/07/2004

Categoría
Category

Junior

Peso
Weight

-73

kgs.

Sexo
Gender

Masculino

Repechage Simple para 16 Competidores

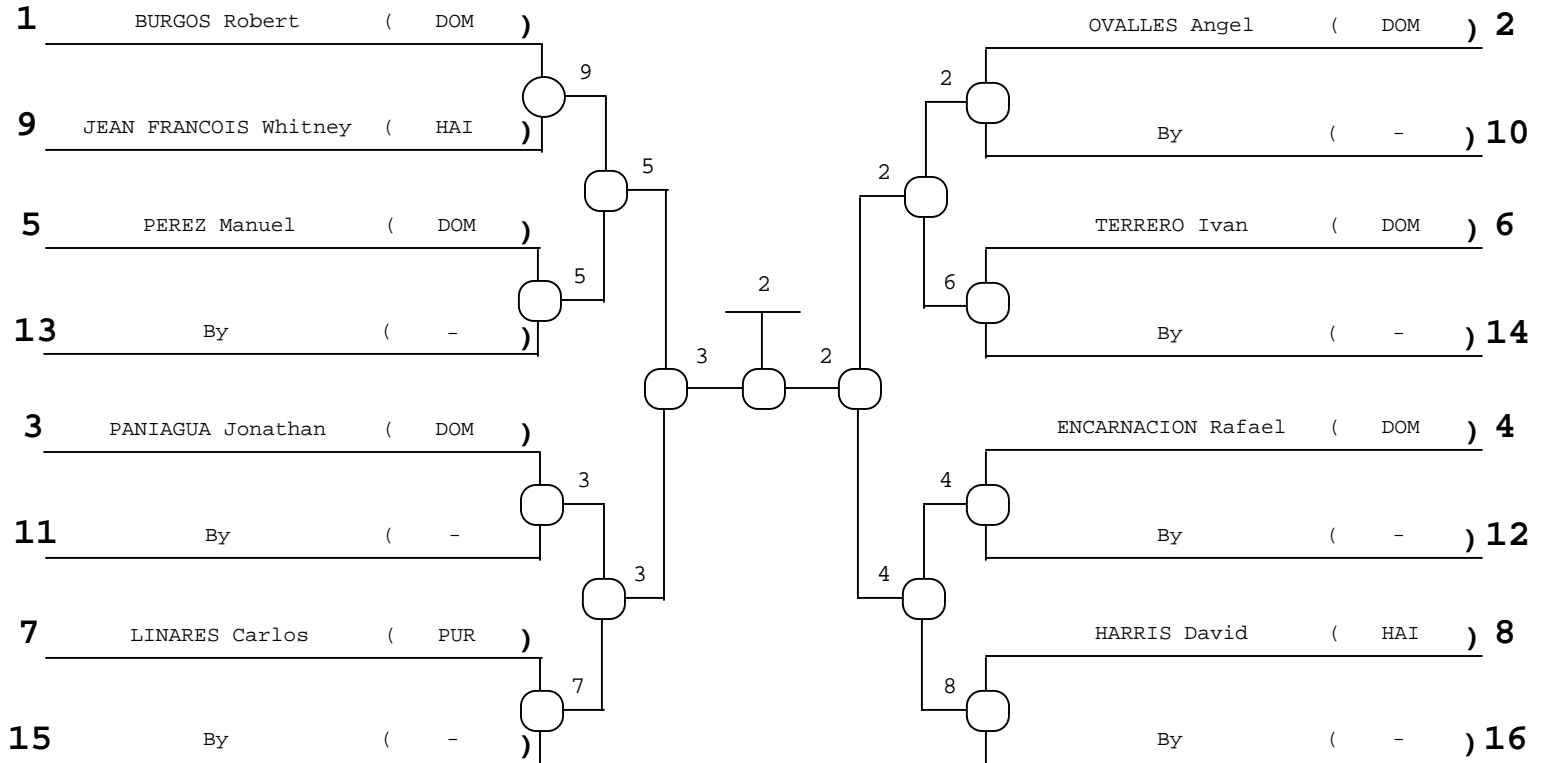

Repechage "A"

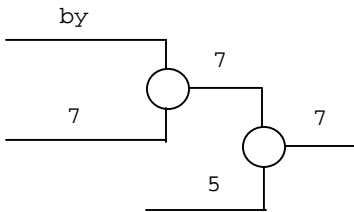

- 1º OVALLES Angel (DOM)
- 2º PANIAGUA Jonathan (DOM)
- 3º LINARES Carlos (PUR)
- 3º TERRERO Ivan (DOM)
- 5º PEREZ Manuel (DOM)
- 5º ENCARNACION Rafael (DOM)
- 7º () ()
- 7º () ()

Repechage "B"

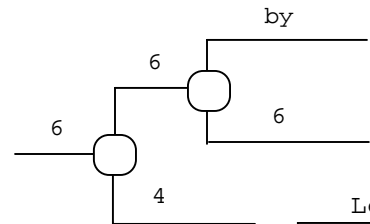

Legend

DWI:	Not Weight
DNA:	Not Show
HD:	Direct Hansok



UNION PANAMERICANA DE JUDO

FEDERACION DOMINICANA DE JUDO



Evento
Event
Lugar
Place

VIII CIRCUITO INTERNACIONAL INFANTIL Y JUVENIL 2004

Casa Nacional del Judo, Sto. Dgo. Rep. Dom. Fecha Date 24/07/2004 al to 24/07/2004

Categoría Junior **Peso** -66 kgs. **Sexo** Masculino
Category **Weight** **Gender**

Repechage Simple para 16 Competidores

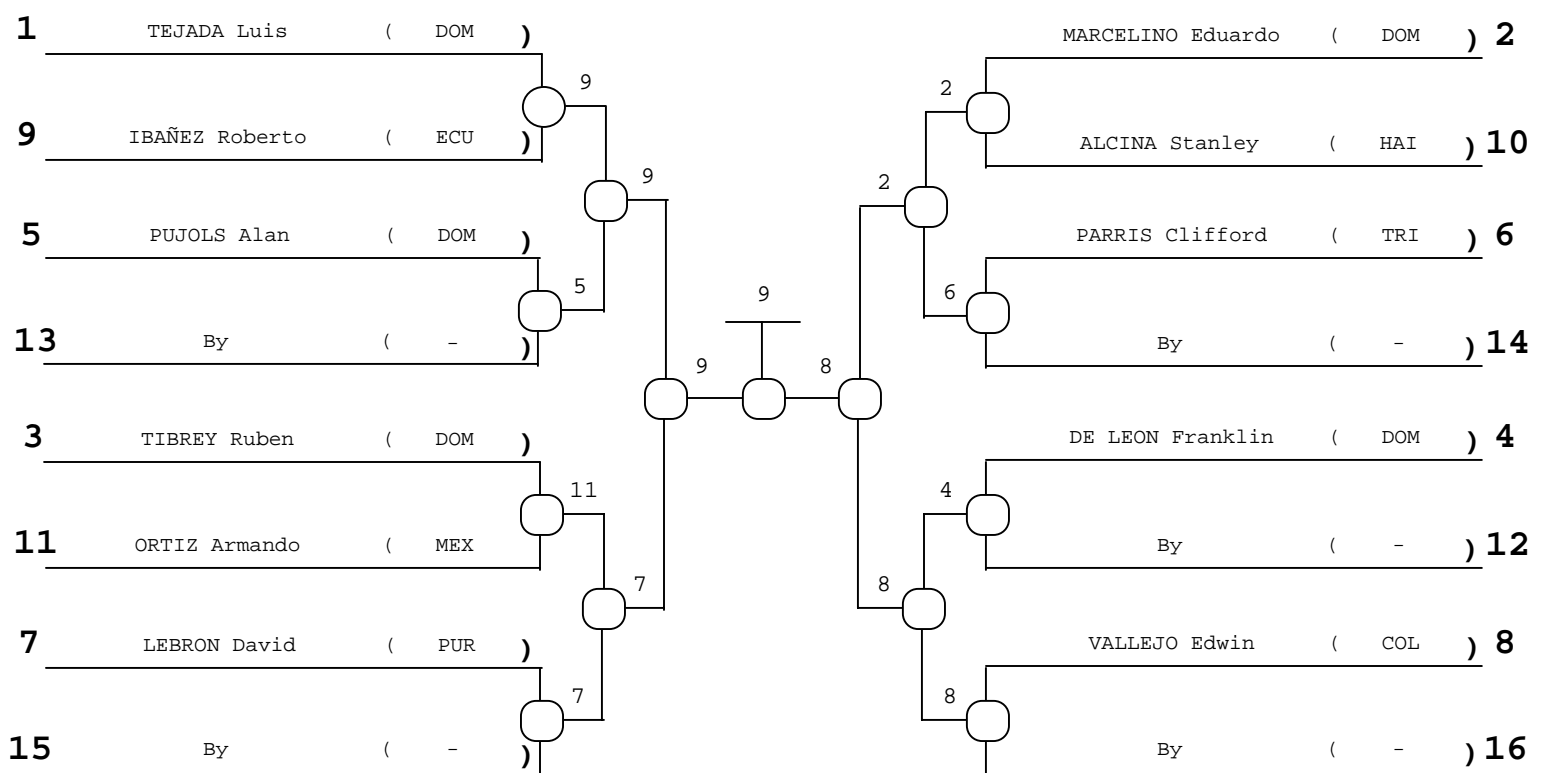

Repechage "A"

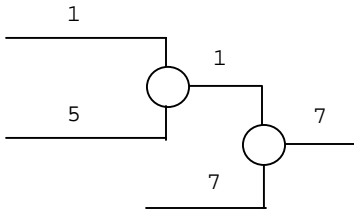

- 1º IBAÑEZ Roberto (ECU)
- 2º VALLEJO Edwin (COL)
- 3º LEBRON David (PUR)
- 3º MARCELINO Eduardo (DOM)
- 5º TEJADA Luis (DOM)
- 5º DE LEON Franklin (DOM)
- 7º _____ ()
- 7º _____ ()

Repechage "B"

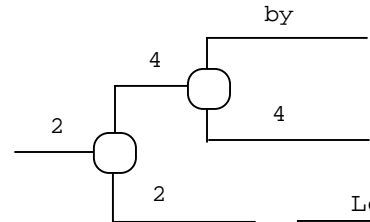

Legend

DWI:	Not Weight
DNA:	Not Show
HD:	Direct Hansok



UNION PANAMERICANA DE JUDO

FEDERACION DOMINICANA DE JUDO



Evento
Event
Lugar
Place

VIII CIRCUITO INTERNACIONAL INFANTIL Y JUVENIL 2004

Casa Nacional del Judo, Sto. Dgo. Rep. Dom.

Fecha 24/07/2004 **al**
Date 24/07/2004 **to**

Categoría
Category

Junior

Peso
Weight

-60 **kgs.**

Sexo
Gender

Masculino

Repechage Simple para 16 Competidores

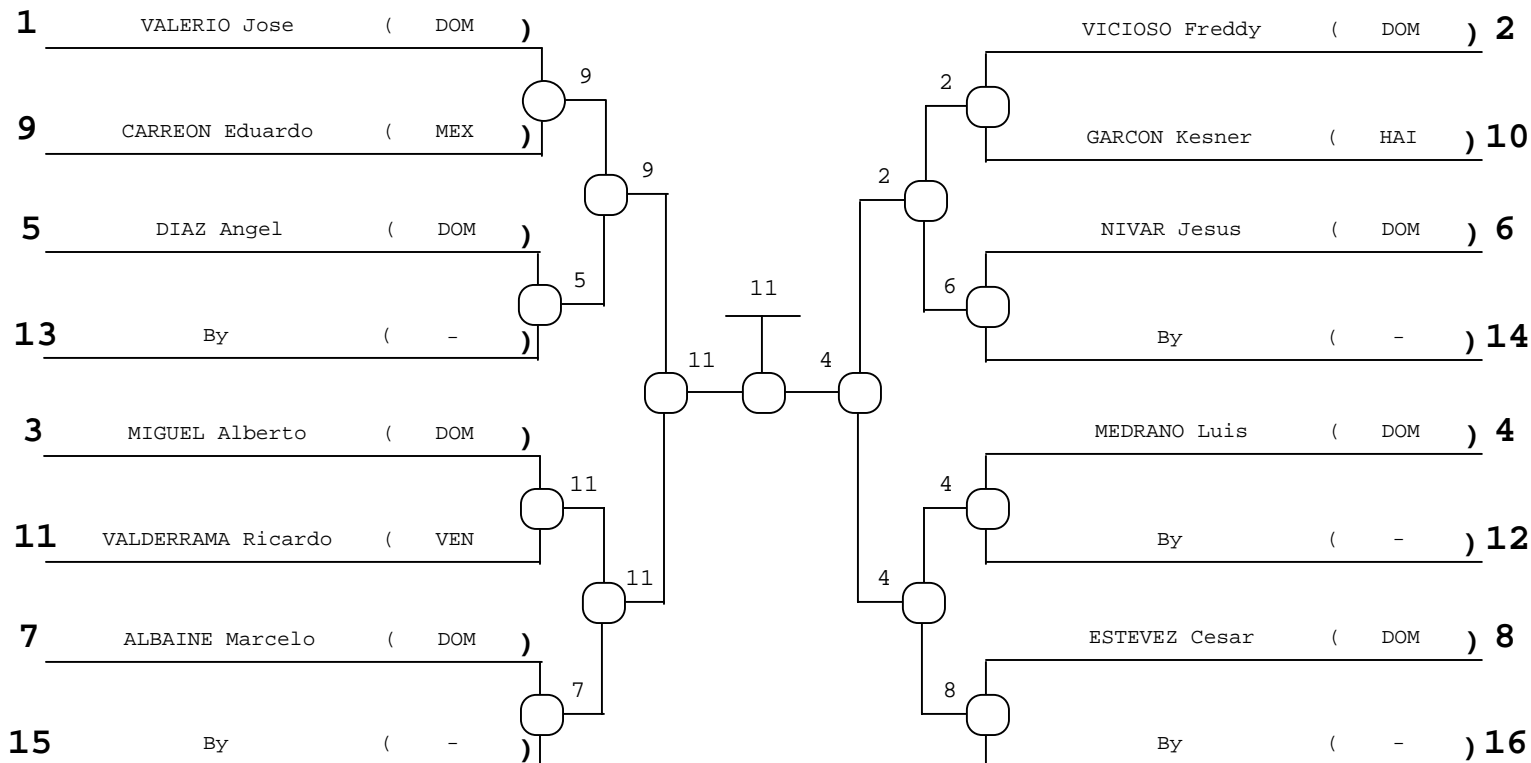

Repechage "A"

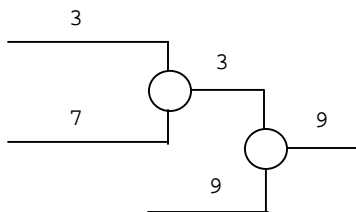

- 1º VALDERRAMA Ricardo (VEN)
- 2º MEDRANO Luis (DOM)
- 3º CARREON Eduardo (MEX)
- 3º VICIOSO Freddy (DOM)
- 5º MIGUEL Alberto (DOM)
- 5º ESTEVEZ Cesar (DOM)
- 7º ()
- 7º ()

Repechage "B"

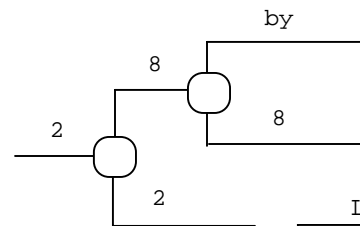

Legend

DWI:	Not Weight
DNA:	Not Show
HD:	Direct Hansok



UNION PANAMERICANA DE JUDO

FEDERACION DOMINICANA DE JUDO



Evento
Event
Lugar
Place

VIII CIRCUITO INTERNACIONAL INFANTIL Y JUVENIL 2004

Casa Nacional del Judo, Sto. Dgo. Rep. Dom.

Fecha 24/07/2004 **al**
Date 24/07/2004 **to**

Categoría
Category

Junior

Peso
Weight

-55 kgs.

Sexo
Gender

Masculino

Repechage Simple para 16 Competidores

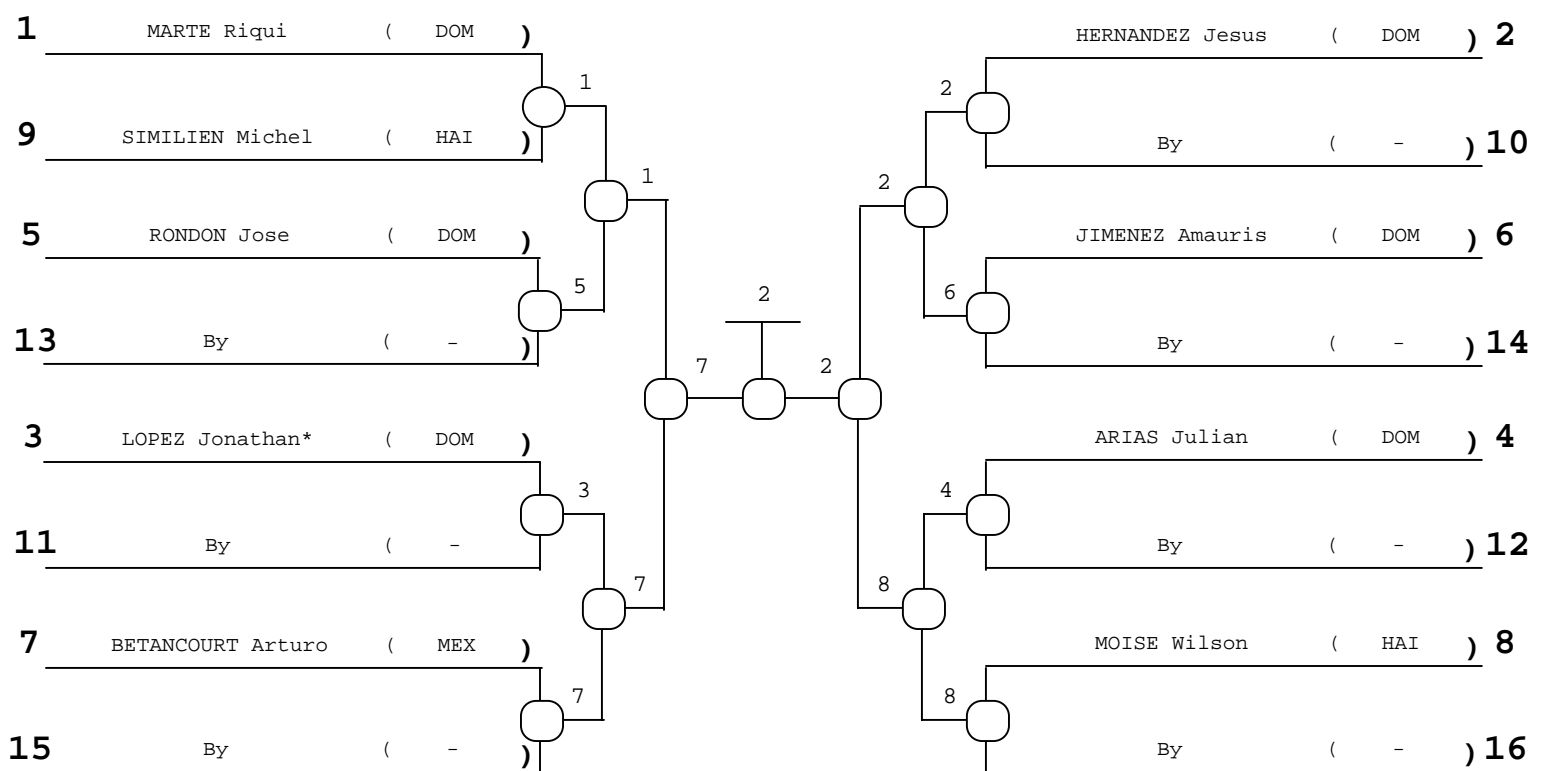

Repechage "A"

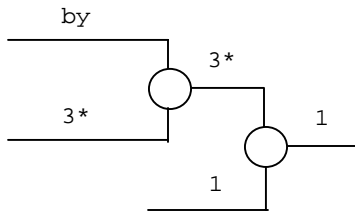

- 1º HERNANDEZ Jesus (DOM)
- 2º BETANCOURT Arturo (MEX)
- 3º MARTE Riqui (DOM)
- 3º JIMENEZ Amauris (DOM)
- 5º LOPEZ Jonathan*H.D (DOM)
- 5º MOISE Wilson (HAI)
- 7º _____ ()
- 7º _____ ()

Repechage "B"

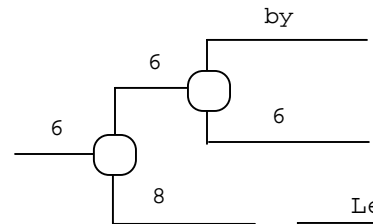

Legend

DWI:	Not Weight
DNA:	Not Show
HD:	Direct Hansok.



**UNION PANAMERICANA DE JUDO
FEDERACION DOMINICANA DE JUDO**



Evento **VIII CIRCUITO INTERNACIONAL INFANTIL Y JUVENIL 2004**
Event

Lugar **Casa Nacional del Judo, Sto. Dgo. Rep. Dom.** **Fecha** **24/07/2004** **al**
Place **Date** **to** **24/07/2004**

Categoría **Junior** **Peso** **+78** **kgs.** **Sexo** **Femenino**
Category **Weight** **Gender**

Eliminatoria Round Robin (Todos contra todos)

Nº	Nombre	País	1	2	3	4	5	Vict.	Ptos.	Lugar
1	HENRIQUEZ Mabel	DOM	■							1
2	--	--		■						
3	--	-			■					
4	--	-				■				
5	--	-					■			

Pool de: _____

Orden de los Combates		
1-2	1-2	1-2
2-3	3-4	3-4
1-3	1-3	1-5
	2-4	2-3
	1-4	4-5
	2-3	1-3
		2-5
		1-4
		3-5
		2-4

1º _____ (DOM)
 2º _____ ()
 3º _____ ()
 3º _____ ()
 5º _____ ()

Símbolo	Marcación	Puntos	Equivale	Inmovilización
○	IPPON	10	HANSOKU MAKE	25 seg.
◐	WAZARI	7	3er SHIDO	de 20 a -25 seg.
◑	YUKO	5	2do SHIDO	de 15 a -20 seg.
◒	KOKA	3	1er SHIDO	de 10 a -15 seg.
⊗	HANTEI	1		



UNION PANAMERICANA DE JUDO
FEDERACION DOMINICANA DE JUDO



Evento **VIII CIRCUITO INTERNACIONAL INFANTIL Y JUVENIL 2004**
Event

Lugar **Casa Nacional del Judo, Sto. Dgo. Rep. Dom.** Fecha **24/07/2004** al **24/07/2004**
Place Date to

Categoría **Junior** Peso **-78** kgs. Sexo **Femenino**
Category Weight Gender

Eliminatoria Round Robin (Todos contra todos)

Nº	Nombre Name	País Country	1	2	3	4	5	V	Ptos.	Lugar Place
1	TELLEZ Martha	MEX	■							
2	RIVERA Mirely	PUR		■						
3	CABRAL Lisa	DOM			■					
4	--	-				■				
5	--	-					■			

Pool de: _____

Orden de los Combates		
1-2	1-2	1-2
2-3	3-4	3-4
1-3	1-3	1-5
	2-4	2-3
	1-4	4-5
	2-3	1-3
		2-5
		1-4
		3-5
		2-4

1º _____ ()
 2º _____ ()
 3º _____ ()
 3º _____ ()
 5º _____ ()

Símbolo	Marcación	Puntos	Equivale	Inmovilización
	IPPON	10	HANSOKU MAKE	25 seg.
	WAZARI	7	3er SHIDO	de 20 a -25 seg.
	YUKO	5	2do SHIDO	de 15 a -20 seg.
	KOKA	3	1er SHIDO	de 10 a -15 seg.
	HANTEI	1		

Tiempo Estimado min
 Pronostic Time
 Total Combates
 Combats Total

Director de Arbitraje
Referee Director

Director Deportivo
Sporting Director



UNION PANAMERICANA DE JUDO
FEDERACION DOMINICANA DE JUDO



Evento **VIII CIRCUITO INTERNACIONAL INFANTIL Y JUVENIL 2004**
Event

Lugar **Casa Nacional del Judo, Sto. Dgo. Rep. Dom.** Fecha **24/07/2004** al **24/07/2004**
Place Date to

Categoría **Junior** Peso **-70** kgs. Sexo **Femenino**
Category Weight Gender

Eliminatoria Round Robin (Todos contra todos)

Nº	Nombre Name	País Country	1	2	3	4	5	V	Ptos.	Lugar Place
1	VIÑA Beatriz	VEN	■							
2	CANO Debbie	PUR		■						
3	CARVAJAL Maritza	COL			■					
4	--	-				■				
5	--	-					■			

Pool de: _____

Orden de los Combates		
1-2	1-2	1-2
2-3	3-4	3-4
1-3	1-3	1-5
	2-4	2-3
	1-4	4-5
	2-3	1-3
		2-5
		1-4
		3-5
		2-4

1º _____ ()
 2º _____ ()
 3º _____ ()
 3º _____ ()
 5º _____ ()

Símbolo	Marcación	Puntos	Equivale	Inmovilización
	IPPON	10	HANSOKU MAKE	25 seg.
	WAZARI	7	3er SHIDO	de 20 a -25 seg.
	YUKO	5	2do SHIDO	de 15 a -20 seg.
	KOKA	3	1er SHIDO	de 10 a -15 seg.
	HANTEI	1		

Tiempo Estimado min
 Pronostic Time
 Total Combates
 Combats Total

 Director de Arbitraje
 Referee Director

 Director Deportivo
 Sporting Director



UNION PANAMERICANA DE JUDO

FEDERACION DOMINICANA DE JUDO



Evento **VIII CIRCUITO INTERNACIONAL INFANTIL Y JUVENIL 2004**
Event _____
Lugar **Casa Nacional del Judo, Sto. Dgo. Rep. Dom.** **Fecha** **24/07/2004** **al** **24/07/2004**
Place _____ **Date** _____ **to** _____
Categoría **Junior** **Peso** **-63** **kgs.** **Sexo** **Femenino**
Category _____ **Weight** _____ **Gender** _____

Repechage Simple para 8 Competidores

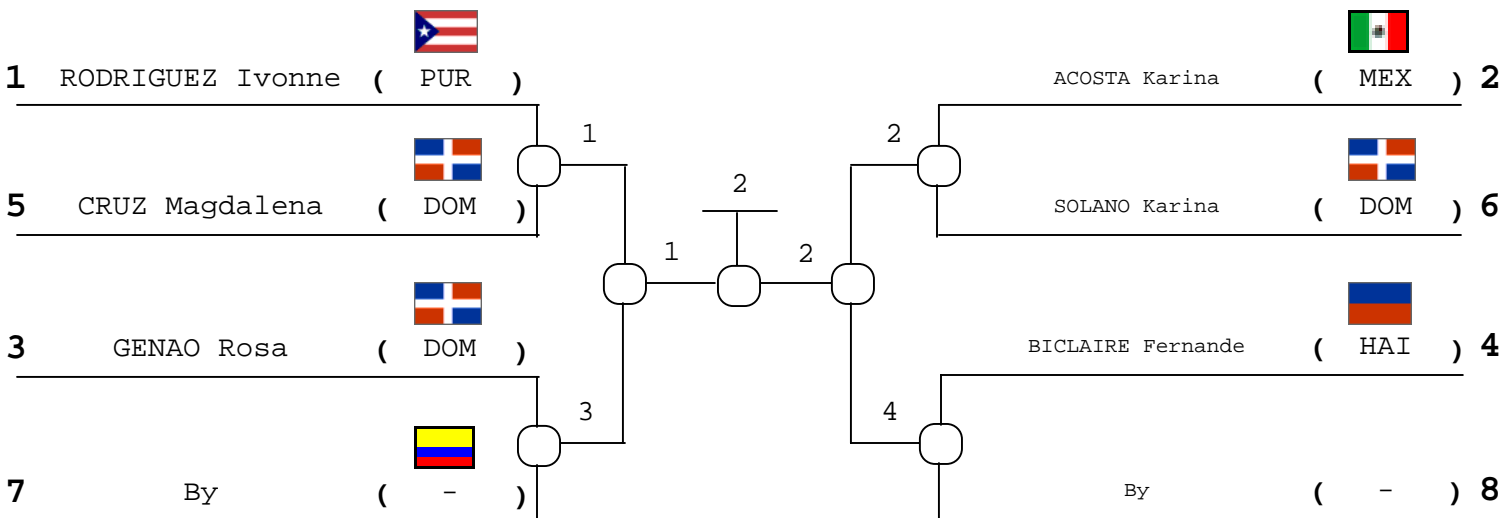

Repechage "A"

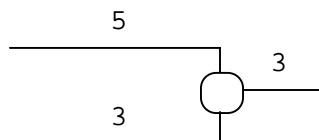

- 1º ACOSTA Karina (MEX)
- 2º RODRIGUEZ Ivonne (PUR)
- 3º GENAO Rosa (DOM)
- 3º BICLAIRE Fernande (HAI)
- 5º CRUZ Magdalena (DOM)
- 5º SOLANO Karina (DOM)
- 7º _____ ()
- 7º _____ ()

Repechage "B"

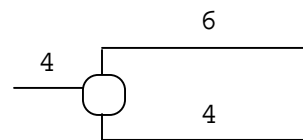



UNION PANAMERICANA DE JUDO

FEDERACION DOMINICANA DE JUDO



Evento **VIII CIRCUITO INTERNACIONAL INFANTIL Y JUVENIL 2004**
Event **VIII CIRCUITO INTERNACIONAL INFANTIL Y JUVENIL 2004**
Lugar **Casa Nacional del Judo, Sto. Dgo. Rep. Dom.** **Fecha** **24/07/2004** **al** **24/07/2004**
Place **Casa Nacional del Judo, Sto. Dgo. Rep. Dom.** **Date** **24/07/2004** **to** **24/07/2004**
Categoría **Junior** **Peso** **-57** **kgs.** **Sexo** **Femenino**
Category **Junior** **Weight** **-57** **kgs.** **Gender** **Femenino**

Repechage Simple para 8 Competidores

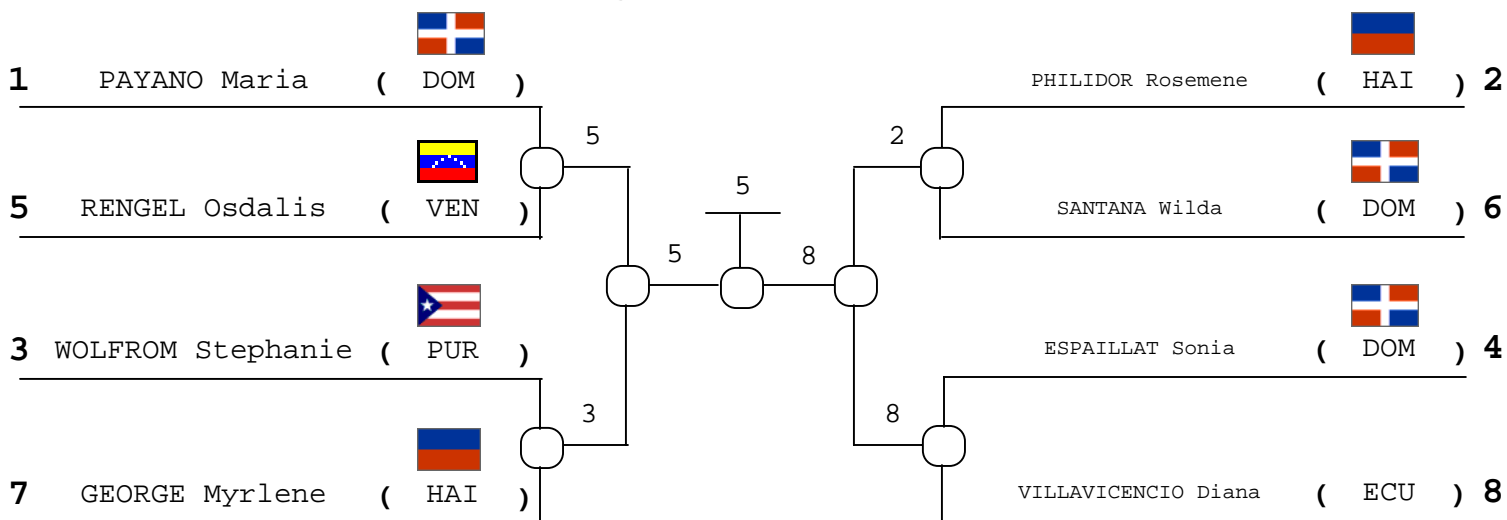

Repechage "A"

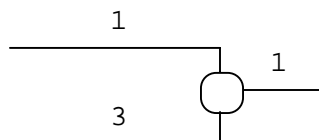

- 1º RENGEL Osdalis (VEN)
- 2º VILLAVICENCIO Diana (ECU)
- 3º PAYANO Maria (DOM)
- 3º PHILIDOR Rosemene (HAI)
- 5º WOLFROM Stephanie (PUR)
- 5º ESPAILLAT Sonia (DOM)
- 7º _____ ()
- 7º _____ ()

Repechage "B"

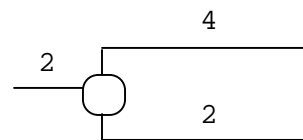



UNION PANAMERICANA DE JUDO

FEDERACION DOMINICANA DE JUDO



Evento **VIII CIRCUITO INTERNACIONAL INFANTIL Y JUVENIL 2004**
Event **VIII CIRCUITO INTERNACIONAL INFANTIL Y JUVENIL 2004**
Lugar **Casa Nacional del Judo, Sto. Dgo. Rep. Dom.** **Fecha** **24/07/2004** **al** **24/07/2004**
Place **Casa Nacional del Judo, Sto. Dgo. Rep. Dom.** **Date** **24/07/2004** **to** **24/07/2004**
Categoría **Junior** **Peso** **-52** **kgs.** **Sexo** **Femenino**
Category **Junior** **Weight** **-52** **kgs.** **Gender** **Femenino**

Repechage Simple para 8 Competidores

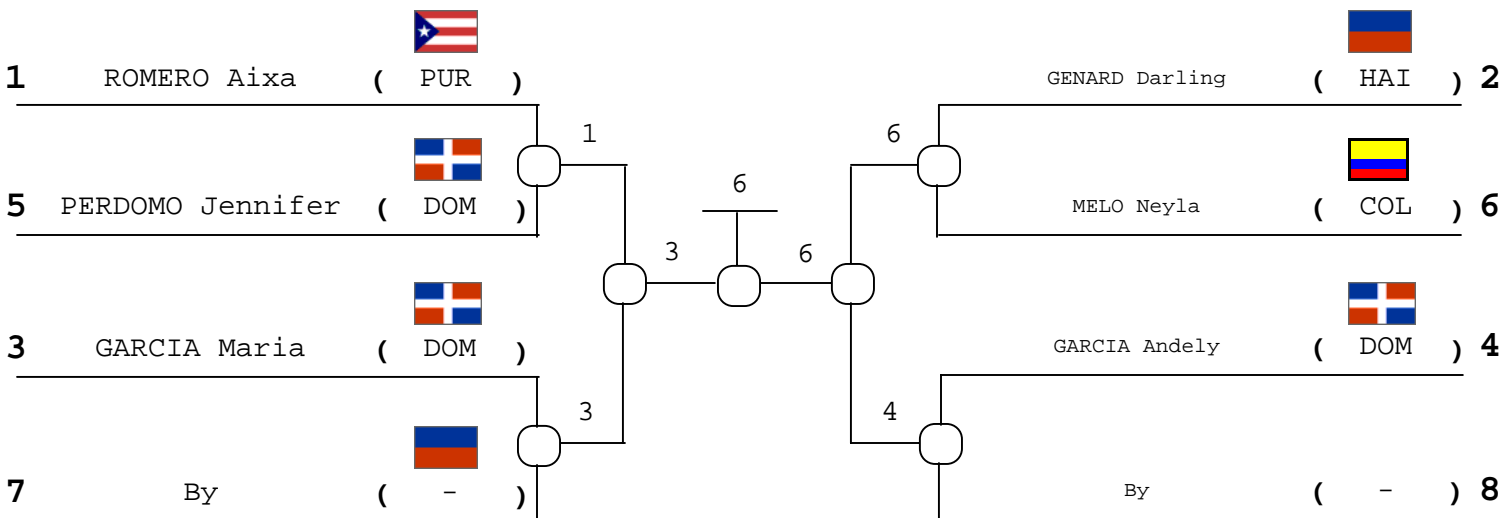

Repechage "A"

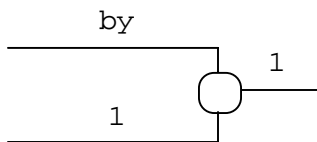

- 1° MELO Neyla (COL)
- 2° GARCIA Maria (DOM)
- 3° ROMERO Aixa (PUR)
- 3° GARCIA Andely (DOM)
- 5° _____ ()
- 5° GENARD Darling (HAI)
- 7° _____ ()
- 7° _____ ()

Repechage "B"

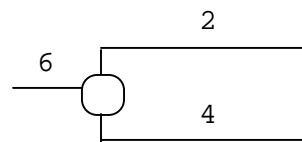



UNION PANAMERICANA DE JUDO

FEDERACION DOMINICANA DE JUDO



Evento
Event
Lugar
Place

VIII CIRCUITO INTERNACIONAL INFANTIL Y JUVENIL 2004

Casa Nacional del Judo, Sto. Dgo. Rep. Dom. **Fecha** 24/07/2004 **al** 24/07/2004
Date **to**

Categoría
Category

Junior

Peso
Weight

-48 **kgs.**

Sexo
Gender

Femenino

Repechage Simple para 16 Competidores

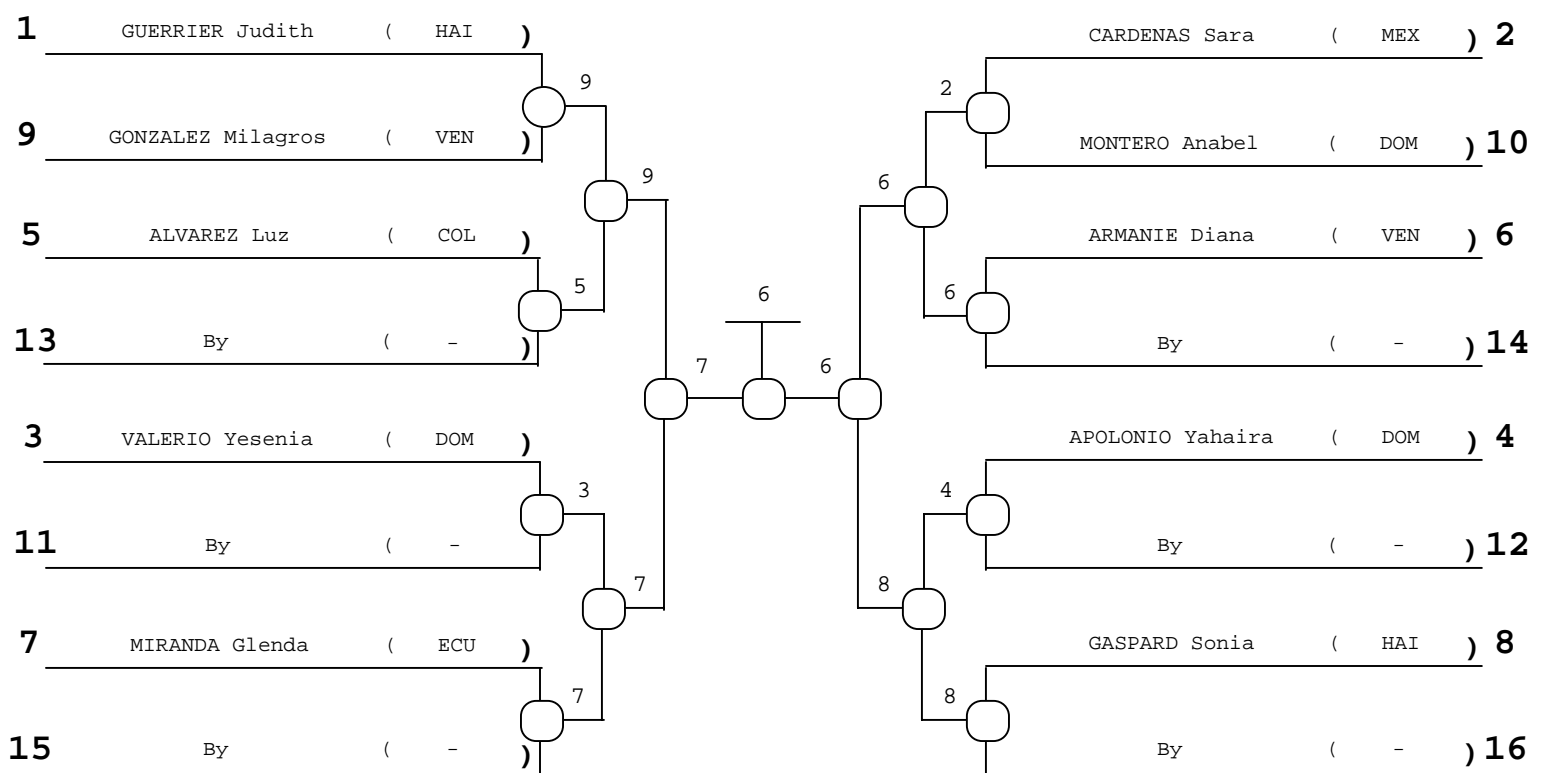

Repechage "A"

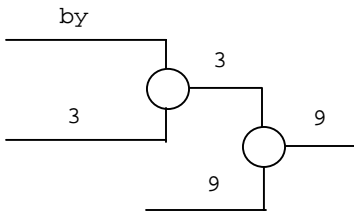

- 10^o ARMANIE Diana (VEN)
- 2^o MIRANDA Glenda (ECU)
- 3^o GONZALEZ Milagros (VEN)
- 3^o CARDENAS Sara (MEX)
- 5^o VALERIO Yesenia (DOM)
- 5^o GASPARD Sonia (HAI)
- 7^o ()
- 7^o ()

Repechage "B"

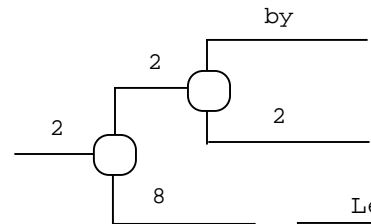

Legend

DWI:	Not Weight
DNA:	Not Show
HD:	Direct Hansok.



**UNION PANAMERICANA DE JUDO
FEDERACION DOMINICANA DE JUDO**



Evento **VIII CIRCUITO INTERNACIONAL INFANTIL Y JUVENIL 2004**
Event

Lugar **Casa Nacional del Judo, Sto. Dgo. Rep. Dom.** **Fecha** **24/07/2004** **al**
Place **Date** **to** **24/07/2004**

Categoría **Junior** **Peso** **-44** **kgs.** **Sexo** **Femenino**
Category **Weight** **Gender**

Eliminatoria Round Robin (Todos contra todos)

Nº	Nombre	País	1	2	3	4	5	Vict.	Ptos.	Lugar
1	PALOS Nidia	MEX	■	5	7			2	12	1
2	MOISE Nadege	HAI	0	■	10			1	10	2
3	MOTA Melissa	DOM	0	0	■			0	0	3
4	--	-				■				
5	--	-					■			

Pool de: _____

Orden de los Combates		
1-2	1-2	1-2
2-3	3-4	3-4
1-3	1-3	1-5
	2-4	2-3
	1-4	4-5
	2-3	1-3
		2-5
		1-4
		3-5
		2-4

- 1º _____ (MEX)
 2º _____ (HAI)
 3º _____ (DOM)
 3º _____ ()
 5º _____ ()

Símbolo	Marcación	Puntos	Equivale	Inmovilización
○	IPPON	10	HANSOKU MAKE	25 seg.
⊖	WAZARI	7	3er SHIDO	de 20 a -25 seg.
⊗	YUKO	5	2do SHIDO	de 15 a -20 seg.
⊕	KOKA	3	1er SHIDO	de 10 a -15 seg.
⊗	HANTEI	1		