











Evento **CAMP. SURAMERICANO JUVENIL Y JUNIOR**
 Lugar **BUENOS AIRES ARGENTINA** Fecha **10/09/2004** al **12/09/2004**
 Place _____ Date _____ to _____

Cuadro de Medallas / Table of Medals







Categoría **Junior General**
 Category _____

Posición Position	País Country	Oro 1st	Plata 2nd	Bronce 3rd	Total
1	BRA 	6	7	2	15
2	VEN 	5	4	2	11
3	ARG 	4	4	7	15
4	ECU 	1	0	0	1
5	URU 	0	1	4	5
6	CHI 	0	0	3	3
7	PER 	0	0	1	1
8	COL 	0	0	1	1
9	PAR 	0	0	0	0
10	BOL 	0	0	0	0
Total		16	16	20	52

Evento **CAMP. SURAMERICANO JUVENIL Y JUNIOR**
 Lugar **BUENOS AIRES ARGENTINA** Fecha **10/09/2004** al **12/09/2004**
 Place _____ Date _____ to _____

Cuadro de Medallas / Table of Medals











Categoría
Category **Junior Fem**

Posición Position	País Country	Oro 1st	Plata 2nd	Bronce 3rd	Total
1	BRA 	4	2	1	7
2	VEN 	2	3	1	6
3	ARG 	2	2	3	7
4	URU 	0	1	2	3
5	PER 	0	0	1	1
6	CHI 	0	0	0	0
Total		8	8	8	24

Evento **CAMP. SURAMERICANO JUVENIL Y JUNIOR**
 Lugar **BUENOS AIRES ARGENTINA** Fecha **10/09/2004** al **12/09/2004**
 Place

Cuadro de Medallas / Table of Medals

Categoría
Category **Junior Masc**

Posición Position	País Country	Oro 1st	Plata 2nd	Bronce 3rd	Total
1	VEN 	3	1	1	5
2	BRA 	2	5	1	8
3	ARG 	2	2	4	8
4	ECU 	1	0	0	1
5	CHI 	0	0	3	3
6	URU 	0	0	2	2
7	COL 	0	0	1	1
8	PER 	0	0	0	0
9	PAR 	0	0	0	0
10	BOL 	0	0	0	0
Total		8	8	12	28



CONFEDERACION SURAMERICANA DE JUDO

CONFEDERACION ARGENTINA DE JUDO



Evento **Event** **CAMP. SURAMERICANO JUVENIL Y JUNIOR**

Lugar **Place** **BUENOS AIRES ARGENTINA** **Fecha** **Date** **10/09/2004** **al** **to** **12/09/2004**

Categoría **Category** **Junior** **Peso** **Weight** **-90** **kgs.** **Sexo** **Gender** **Masculino**

Eliminatoria Round Robin (Todos contra todos)

Nº	Nombre	País	1	2	3	4	5	Vict.	Ptos.	Lugar
1	RODRÍGUEZ Rafael	ARG		0	0			0	0	2
2	KOGA Ricardo	BRA	10		10			2	20	1
3	--	-								
4	--	-								
5	--	-								

Pool de: _____

Orden de los Combates		
1-2	1-2	1-2
2-3	3-4	3-4
1-3	1-3	1-5
	2-4	2-3
	1-4	4-5
	2-3	1-3
		2-5
		1-4
		3-5
		2-4

- 1º _____ (BRA)
- 2º _____ (ARG)
- 3º _____ ()
- 3º _____ ()
- 5º _____ ()

Símbolo	Marcación	Puntos	Equivale	Inmovilización
○	IPPON	10	HANSOKU MAKE	25 seg.
⊖	WAZARI	7	3er SHIDO	de 20 a -25 seg.
⊗	YUKO	5	2do SHIDO	de 15 a -20 seg.
⊕	KOKA	3	1er SHIDO	de 10 a -15 seg.
⊗	HANTEI	1		



CONFEDERACION SURAMERICANA DE JUDO

CONFEDERACION ARGENTINA DE JUDO



Evento **CAMP. SURAMERICANO JUVENIL Y JUNIOR**

Lugar **BUENOS AIRES ARGENTINA** **Fecha** **10/09/2004** **al** **12/09/2004**

Categoría **Junior** **Peso** **-81** **kgs.** **Sexo** **Masculino**

Eliminatoria Round Robin (Todos contra todos)

Nº	Nombre	País	1	2	3	4	5	Vict.	Ptos.	Lugar
1	RETAMALES Fabian	CHI		0	0	0	0	0	0	5
2	FRANCO Omero	BRA	5		10	10	0	3	23	2
3	PLAZA Jorge	ARG	10	0		7	0	2	17	3
4	APRAHAMIAN Pablo	URU	10	0	0		0	1	10	3
5	RODRÍGUEZ Melvin	VEN	10	10	10	10		4	40	1

Pool de: _____

Orden de los Combates		
1-2	1-2	1-2
2-3	3-4	3-4
1-3	1-3	1-5
	2-4	2-3
	1-4	4-5
	2-3	1-3
		2-5
		1-4
		3-5
		2-4

- 1º _____ (VEN)
- 2º _____ (BRA)
- 3º _____ (ARG)
- 3º _____ (URU)
- 5º _____ (CHI)

Símbolo	Marcación	Puntos	Equivale	Inmovilización
○	IPPON	10	HANSOKU MAKE	25 seg.
⊖	WAZARI	7	3er SHIDO	de 20 a -25 seg.
⊗	YUKO	5	2do SHIDO	de 15 a -20 seg.
⊕	KOKA	3	1er SHIDO	de 10 a -15 seg.
⊗	HANTEI	1		



CONFEDERACION SURAMERICANA DE JUDO

CONFEDERACION ARGENTINA DE JUDO



Evento **Event** **CAMP. SURAMERICANO JUVENIL Y JUNIOR**

Lugar **Place** **BUENOS AIRES ARGENTINA** **Fecha** **Date** **10/09/2004** **al** **to** **12/09/2004**

Categoría **Category** **Junior** **Peso** **Weight** **-78** **kgs.** **Sexo** **Gender** **Femenino**

Eliminatoria Round Robin (Todos contra todos)

Nº	Nombre	País	1	2	3	4	5	Vict.	Ptos.	Lugar
1	PEREIRA Natalia	BRA		0	0			0	0	2
2	LITARDO Laura	ARG	10		10			2	20	1
3	--	-								
4	--	-								
5	--	-								

Pool de: _____

Orden de los Combates		
1-2	1-2	1-2
2-3	3-4	3-4
1-3	1-3	1-5
	2-4	2-3
	1-4	4-5
	2-3	1-3
		2-5
		1-4
		3-5
		2-4

- 1º _____ (ARG)
- 2º _____ (BRA)
- 3º _____ ()
- 3º _____ ()
- 5º _____ ()

Símbolo	Marcación	Puntos	Equivale	Inmovilización
○	IPPON	10	HANSOKU MAKE	25 seg.
⊖	WAZARI	7	3er SHIDO	de 20 a -25 seg.
⊗	YUKO	5	2do SHIDO	de 15 a -20 seg.
⊕	KOKA	3	1er SHIDO	de 10 a -15 seg.
⊗	HANTEI	1		



CONFEDERACION SURAMERICANA DE JUDO

CONFEDERACION ARGENTINA DE JUDO



Evento
Event **CAMP. SURAMERICANO JUVENIL Y JUNIOR**

Lugar
Place **BUENOS AIRES ARGENTINA** **Fecha**
Date **10/09/2004** **al**
to **12/09/2004**

Categoría
Category **Junior** **Peso**
Weight **-73** **kgs.** **Sexo**
Gender **Masculino**

Eliminatoria Round Robin (Todos contra todos)

Nº	Nombre	País	1	2	3	4	5	Vict.	Ptos.	Lugar
1	PERALTA José	ARG		5	0	10	3	3	18	2
2	RETAMALES Fabian	CHI	0		0	10	0	1	10	3
3	BRAGA Felipe	BRA	5	10		10	7	4	32	1
4	KIM Antonio	PAR	0	0	0		0	0	0	5
5	ALMEIDA Pablo	URU	0	5	0	10		2	15	3

Pool de: _____

Orden de los Combates		
1-2	1-2	1-2
2-3	3-4	3-4
1-3	1-3	1-5
	2-4	2-3
	1-4	4-5
	2-3	1-3
		2-5
		1-4
		3-5
		2-4

- 1º _____ (BRA)
- 2º _____ (ARG)
- 3º _____ (URU)
- 3º _____ (URU)
- 5º _____ (PAR)

Símbolo	Marcación	Puntos	Equivale	Inmovilización
○	IPPON	10	HANSOKU MAKE	25 seg.
⊖	WAZARI	7	3er SHIDO	de 20 a -25 seg.
⊗	YUKO	5	2do SHIDO	de 15 a -20 seg.
⊕	KOKA	3	1er SHIDO	de 10 a -15 seg.
⊗	HANTEI	1		



CONFEDERACION SURAMERICANA DE JUDO

CONFEDERACION ARGENTINA DE JUDO



Evento **CAMP. SURAMERICANO JUVENIL Y JUNIOR**

Lugar **BUENOS AIRES ARGENTINA** **Fecha** **10/09/2004** **al** **12/09/2004**

Categoría **Junior** **Peso** **-70** **kgs.** **Sexo** **Femenino**

Eliminatoria Round Robin (Todos contra todos)

Nº	Nombre	País	1	2	3	4	5	Vict.	Ptos.	Lugar
1	PAPAIANI Fiorela	URU		5	0	0		1	5	3
2	MERCEGUE Sonia	ARG	0		0	0		0	0	4
3	PEREIRA Rubiane	BRA	10	10		5		3	3	1
4	VIÑA Beatriz	VEN	10	7	0			2	2	2
5	--	-								

Pool de: _____

Orden de los Combates		
1-2	1-2	1-2
2-3	3-4	3-4
1-3	1-3	1-5
	2-4	2-3
	1-4	4-5
	2-3	1-3
		2-5
		1-4
		3-5
		2-4

- 1º _____ (BRA)
- 2º _____ (VEN)
- 3º _____ (URU)
- 3º _____ (ARG)
- 5º _____ ()

Símbolo	Marcación	Puntos	Equivale	Inmovilización
○	IPPON	10	HANSOKU MAKE	25 seg.
⊖	WAZARI	7	3er SHIDO	de 20 a -25 seg.
⊗	YUKO	5	2do SHIDO	de 15 a -20 seg.
⊕	KOKA	3	1er SHIDO	de 10 a -15 seg.
⊗	HANTEI	1		



CONFEDERACION SURAMERICANA DE JUDO

CONFEDERACION ARGENTINA DE JUDO



Evento **CAMP. SURAMERICANO JUVENIL Y JUNIOR**

Lugar **BUENOS AIRES ARGENTINA** **Fecha** **10/09/2004** **al** **12/09/2004**

Categoría **Junior** **Peso** **-66** **kgs.** **Sexo** **Masculino**

Eliminatoria Round Robin (Todos contra todos)

Nº	Nombre	País	1	2	3	4	5	Vict.	Ptos.	Lugar
1	IBAÑEZ Roberto	ECU		3	5	3	5	4	16	1
2	ROSENDO José	BRA	0		10	5	0	2	15	2
3	SORIA Pablo	ARG	0	0		7	5	2	12	3
4	LOZA Franco	PER	0	0	0		0	0	0	5
5	VALLEJO Edwin	COL	0	3	0	10		2	13	3

Pool de: _____

Orden de los Combates		
1-2	1-2	1-2
2-3	3-4	3-4
1-3	1-3	1-5
	2-4	2-3
	1-4	4-5
	2-3	1-3
		2-5
		1-4
		3-5
		2-4

- 1º _____ (ECU)
- 2º _____ (BRA)
- 3º _____ (ARG)
- 3º _____ (COL)
- 5º _____ (PER)

Símbolo	Marcación	Puntos	Equivale	Inmovilización
○	IPPON	10	HANSOKU MAKE	25 seg.
⊖	WAZARI	7	3er SHIDO	de 20 a -25 seg.
⊗	YUKO	5	2do SHIDO	de 15 a -20 seg.
⊕	KOKA	3	1er SHIDO	de 10 a -15 seg.
⊗	HANTEI	1		



CONFEDERACION SURAMERICANA DE JUDO
CONFEDERACION ARGENTINA DE JUDO



Evento **CAMP. SURAMERICANO JUVENIL Y JUNIOR**
Lugar **BUENOS AIRES ARGENTINA** **Fecha** **10/09/2004** **al** **12/09/2004**
Place **Date** **to**
Categoría **Junior** **Peso** **-63** **kgs.** **Sexo** **Femenino**
Category **Weight** **Gender**

Eliminatoria Round Robin (Todos contra todos)

Nº	Nombre	País	1	2	3	4	5	Vict.	Ptos.	Lugar
1	PLAZA Laura	ARG	■	7	0	0		1	7	3
2	GAJARDO Yanny	CHI	0	■	0	0		0	0	4
3	FIGOLI Irene	URU	10	10	■	0		2	20	2
4	ESTEVEVES María	BRA	10	10	10	■		3	30	1
5	--	-					■			

Pool de: _____

Orden de los Combates		
1-2	1-2	1-2
2-3	3-4	3-4
1-3	1-3	1-5
	2-4	2-3
	1-4	4-5
	2-3	1-3
		2-5
		1-4
		3-5
		2-4

- 1º _____ (BRA)
 2º _____ (URU)
 3º _____ (ARG)
 3º _____ (CHI)
 5º _____ ()

Símbolo	Marcación	Puntos	Equivale	Inmovilización
○	IPPON	10	HANSOKU MAKE	25 seg.
◐	WAZARI	7	3er SHIDO	de 20 a -25 seg.
◑	YUKO	5	2do SHIDO	de 15 a -20 seg.
◒	KOKA	3	1er SHIDO	de 10 a -15 seg.
⊗	HANTEI	1		



CONFEDERACION SURAMERICANA DE JUDO

CONFEDERACION ARGENTINA DE JUDO



Evento / Event: **CAMP. SURAMERICANO JUVENIL Y JUNIOR**
Lugar / Place: **BUENOS AIRES ARGENTINA** **Fecha / Date:** **10/09/2004** **al / to:** **12/09/2004**
Categoría / Category: **Junior** **Peso / Weight:** **-60** **kgs. / Gender:** **Masculino**

Repechage Doble Cruzado para 8 Competidores

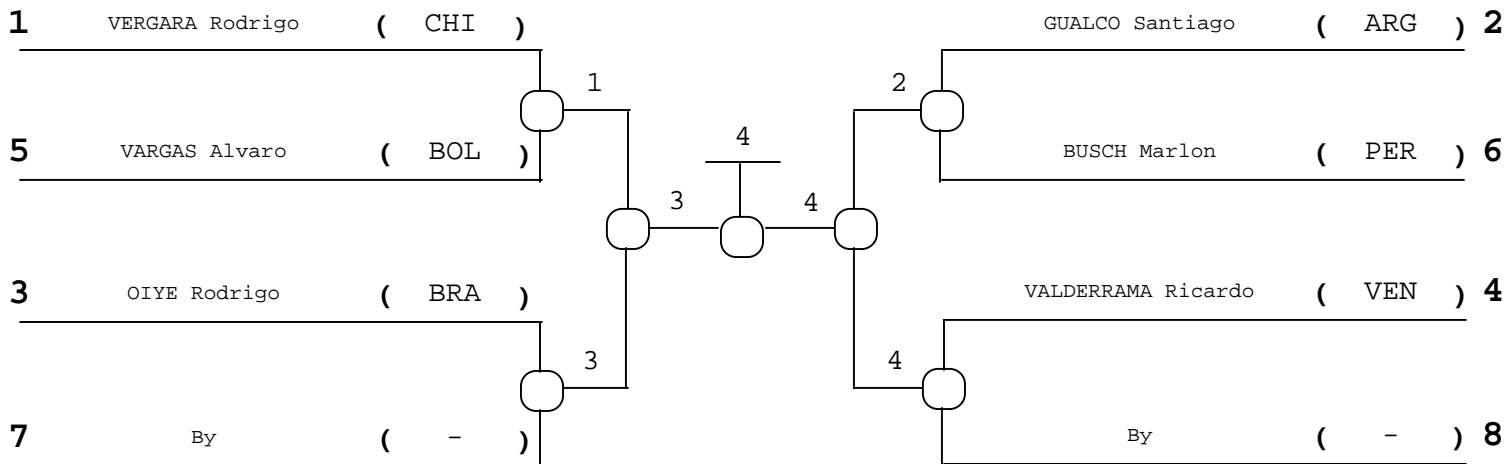

Repechage "A"

Repechage "B"

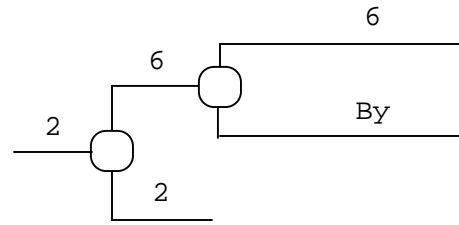
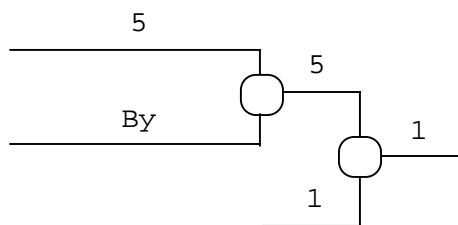

- 1º VALDERRAMA Ricardo (VEN)
- 2º OIYE Rodrigo (BRA)
- 3º VERGARA Rodrigo (CHI)
- 3º GUALCO Santiago (ARG)
- 5º VARGAS Alvaro (BOL)
- 5º BUSCH Marlon (PER)



CONFEDERACION SURAMERICANA DE JUDO

CONFEDERACION ARGENTINA DE JUDO



Evento **Event** **CAMP. SURAMERICANO JUVENIL Y JUNIOR**

Lugar **Place** **BUENOS AIRES ARGENTINA** **Fecha** **Date** **10/09/2004** **al** **to** **12/09/2004**

Categoría **Category** **Junior** **Peso** **Weight** **-57** **kgs.** **Sexo** **Gender** **Femenino**

Eliminatoria Round Robin (Todos contra todos)

Nº	Nombre	País	1	2	3	4	5	Vict.	Ptos.	Lugar
1	CASTILLO Mirella	PER		0	0	0		0	0	4
2	RENGEL Osdalis	VEN	10		10	5		3	25	1
3	PILAT Griselda	ARG	5	0		0		1	5	3
4	POLASTRINI Alessandra	BRA	5	0	10			2	15	2
5	--	-								

Pool de: _____

Orden de los Combates		
1-2	1-2	1-2
2-3	3-4	3-4
1-3	1-3	1-5
	2-4	2-3
	1-4	4-5
	2-3	1-3
		2-5
		1-4
		3-5
		2-4

- 1º _____ (VEN)
- 2º _____ (BRA)
- 3º _____ (ARG)
- 3º _____ (PER)
- 5º _____ ()

Símbolo	Marcación	Puntos	Equivale	Inmovilización
○	IPPON	10	HANSOKU MAKE	25 seg.
⊖	WAZARI	7	3er SHIDO	de 20 a -25 seg.
⊗	YUKO	5	2do SHIDO	de 15 a -20 seg.
⊕	KOKA	3	1er SHIDO	de 10 a -15 seg.
⊗	HANTEI	1		



CONFEDERACION SURAMERICANA DE JUDO

CONFEDERACION ARGENTINA DE JUDO



Evento **Event** **CAMP. SURAMERICANO JUVENIL Y JUNIOR**

Lugar **Place** **BUENOS AIRES ARGENTINA** **Fecha** **Date** **10/09/2004** **al** **to** **12/09/2004**

Categoría **Category** **Junior** **Peso** **Weight** **-55** **kgs.** **Sexo** **Gender** **Masculino**

Eliminatoria Round Robin (Todos contra todos)

Nº	Nombre	País	1	2	3	4	5	Vict.	Ptos.	Lugar
1	GÚZMAN Erwin	CHI			0	0		0	0	3
2	DE CUBA Edgar	VEN	5		0	5		2	10	2
3	RUSSO Mariano	ARG	7	3		0		2	10	1
4	BRITO Dyego	BRA	5	0	3			2	8	3
5	--	-								

Pool de: _____

Orden de los Combates		
1-2	1-2	1-2
2-3	3-4	3-4
1-3	1-3	1-5
	2-4	2-3
	1-4	4-5
	2-3	1-3
		2-5
		1-4
		3-5
		2-4

- 1º _____ (ARG)
- 2º _____ (VEN)
- 3º _____ (CHI)
- 3º _____ (BRA)
- 5º _____ ()

Símbolo	Marcación	Puntos	Equivale	Inmovilización
○	IPPON	10	HANSOKU MAKE	25 seg.
⊖	WAZARI	7	3er SHIDO	de 20 a -25 seg.
⊗	YUKO	5	2do SHIDO	de 15 a -20 seg.
⊕	KOKA	3	1er SHIDO	de 10 a -15 seg.
⊗	HANTEI	1		



CONFEDERACION SURAMERICANA DE JUDO
CONFEDERACION ARGENTINA DE JUDO



Evento **CAMP. SURAMERICANO JUVENIL Y JUNIOR**
Lugar **BUENOS AIRES ARGENTINA** **Fecha** **10/09/2004** **al** **12/09/2004**
Place **BUENOS AIRES ARGENTINA** **Date** **10/09/2004** **to** **12/09/2004**
Categoría **Junior** **Peso** **-52** **kgs.** **Sexo** **Femenino**
Category **Junior** **Weight** **-52** **kgs.** **Gender** **Femenino**

Eliminatoria Round Robin (Todos contra todos)

Nº	Nombre	País	1	2	3	4	5	Vict.	Ptos.	Lugar
1	FLORES Tania	CHI		0	0	0	0	0	0	5
2	BIELAKOWICZ Zarina	ARG	10		5	0	3	3	18	2
3	MARTIN Armin	VEN	5	0		0	0	1	5	3
4	BARROS Mariana	BRA	10	10	7		5	4	32	1
5	DELGADO Karla	PER	10	0	7	0		2	17	3

Pool de: _____

Orden de los Combates		
1-2	1-2	1-2
2-3	3-4	3-4
1-3	1-3	1-5
	2-4	2-3
	1-4	4-5
	2-3	1-3
		2-5
		1-4
		3-5
		2-4

- 1º _____ (BRA)
 2º _____ (ARG)
 3º _____ (PER)
 3º _____ (VEN)
 5º _____ (CHI)

Símbolo	Marcación	Puntos	Equivale	Inmovilización
○	IPPON	10	HANSOKU MAKE	25 seg.
⊖	WAZARI	7	3er SHIDO	de 20 a -25 seg.
⊗	YUKO	5	2do SHIDO	de 15 a -20 seg.
⊕	KOKA	3	1er SHIDO	de 10 a -15 seg.
⊗	HANTEI	1		



CONFEDERACION SURAMERICANA DE JUDO
CONFEDERACION ARGENTINA DE JUDO



Evento **CAMP. SURAMERICANO JUVENIL Y JUNIOR**
Lugar **BUENOS AIRES ARGENTINA** **Fecha** **10/09/2004** **al** **12/09/2004**
Place **BUENOS AIRES ARGENTINA** **Date** **10/09/2004** **to** **12/09/2004**
Categoría **Junior** **Peso** **-48** **kgs.** **Sexo** **Femenino**
Category **Junior** **Weight** **-48** **kgs.** **Gender** **Femenino**

Eliminatoria Round Robin (Todos contra todos)

Nº	Nombre	País	1	2	3	4	5	Vict.	Ptos.	Lugar
1	FERNÁNDEZ Paola	URU	■	0	5	0		1	5	3
2	ARMANIE Diana	VEN	10	■	10	0		2	20	2
3	GALVAO Roberta	BRA	0	0	■	0		0	0	4
4	BERMÚDEZ Patricia	ARG	10	1	10	■		3	21	1
5	--	-					■			

Pool de: _____

Orden de los Combates		
1-2	1-2	1-2
2-3	3-4	3-4
1-3	1-3	1-5
	2-4	2-3
	1-4	4-5
	2-3	1-3
		2-5
		1-4
		3-5
		2-4

- 1º _____ (ARG)
 2º _____ (VEN)
 3º _____ (URU)
 3º _____ (BRA)
 5º _____ ()

Símbolo	Marcación	Puntos	Equivale	Inmovilización
○	IPPON	10	HANSOKU MAKE	25 seg.
◐	WAZARI	7	3er SHIDO	de 20 a -25 seg.
◑	YUKO	5	2do SHIDO	de 15 a -20 seg.
◒	KOKA	3	1er SHIDO	de 10 a -15 seg.
⊗	HANTEI	1		



CONFEDERACION SURAMERICANA DE JUDO
CONFEDERACION ARGENTINA DE JUDO



Evento **CAMP. SURAMERICANO JUVENIL Y JUNIOR**
Lugar **BUENOS AIRES ARGENTINA** **Fecha** **10/09/2004** **al** **12/09/2004**
Place **BUENOS AIRES ARGENTINA** **Date** **10/09/2004** **to** **12/09/2004**
Categoría **Junior** **Peso** **-44** **kgs.** **Sexo** **Femenino**
Category **Junior** **Weight** **-44** **kgs.** **Gender** **Femenino**

Eliminatoria Round Robin (Todos contra todos)

Nº	Nombre	País	1	2	3	4	5	Vict.	Ptos.	Lugar
1	ARAUJO Tassia	BRA	█	0	10	0		1	10	3
2	PARETO Paula	ARG	10	█	10	0		2	20	2
3	CHIGUAY Macarena	CHI	0	0	█	0		0	0	4
4	GONZÁLEZ Milagros	VEN	5	3	10	█		3	18	1
5	--	-					█			

Pool de: _____

Orden de los Combates		
1-2	1-2	1-2
2-3	3-4	3-4
1-3	1-3	1-5
	2-4	2-3
	1-4	4-5
	2-3	1-3
		2-5
		1-4
		3-5
		2-4

- 1º _____ (VEN)
 2º _____ (ARG)
 3º _____ (BRA)
 3º _____ (CHI)
 5º _____ ()

Símbolo	Marcación	Puntos	Equivale	Inmovilización
○	IPPON	10	HANSOKU MAKE	25 seg.
◐	WAZARI	7	3er SHIDO	de 20 a -25 seg.
◑	YUKO	5	2do SHIDO	de 15 a -20 seg.
◒	KOKA	3	1er SHIDO	de 10 a -15 seg.
⊗	HANTEI	1		



CONFEDERACION SURAMERICANA DE JUDO

CONFEDERACION ARGENTINA DE JUDO



Evento **CAMP. SURAMERICANO JUVENIL Y JUNIOR**

Lugar **BUENOS AIRES ARGENTINA** **Fecha** **10/09/2004** **al** **12/09/2004**

Categoría **Junior** **Peso** **+100** **kgs.** **Sexo** **Masculino**

Eliminatoria Round Robin (Todos contra todos)

Nº	Nombre	País	1	2	3	4	5	Vict.	Ptos.	Lugar
1	SANTOS Isaias	BRA		10	0			1	10	2
2	BRUNO Mauro	ARG	0		0			0	0	3
3	CAMACHO Oswald	VEN	10	5				2	15	1
4	--	-								
5	--	-								

Pool de: _____

Orden de los Combates		
1-2	1-2	1-2
2-3	3-4	3-4
1-3	1-3	1-5
	2-4	2-3
	1-4	4-5
	2-3	1-3
		2-5
		1-4
		3-5
		2-4

- 1º _____ (VEN)
- 2º _____ (BRA)
- 3º _____ (ARG)
- 3º _____ ()
- 5º _____ ()

Símbolo	Marcación	Puntos	Equivale	Inmovilización
○	IPPON	10	HANSOKU MAKE	25 seg.
⊖	WAZARI	7	3er SHIDO	de 20 a -25 seg.
⊗	YUKO	5	2do SHIDO	de 15 a -20 seg.
⊕	KOKA	3	1er SHIDO	de 10 a -15 seg.
⊗	HANTEI	1		



CONFEDERACION SURAMERICANA DE JUDO

CONFEDERACION ARGENTINA DE JUDO



Evento **Event** **CAMP. SURAMERICANO JUVENIL Y JUNIOR**

Lugar **Place** **BUENOS AIRES ARGENTINA** **Fecha** **Date** **10/09/2004** **al** **to** **12/09/2004**

Categoría **Category** **Junior** **Peso** **Weight** **+78** **kgs.** **Sexo** **Gender** **Femenino**

Eliminatoria Round Robin (Todos contra todos)

Nº	Nombre	País	1	2	3	4	5	Vict.	Ptos.	Lugar
1	MENA Lucrecia	ARG		0	0			0	0	3
2	FLOQUET Camila	BRA	10		3			2	13	1
3	MARCANO Elisneidy	VEN	10	0				1	10	2
4	--	-								
5	--	-								

Pool de: _____

Orden de los Combates		
1-2	1-2	1-2
2-3	3-4	3-4
1-3	1-3	1-5
	2-4	2-3
	1-4	4-5
	2-3	1-3
		2-5
		1-4
		3-5
		2-4

- 1º _____ (BRA)
- 2º _____ (VEN)
- 3º _____ (ARG)
- 3º _____ ()
- 5º _____ ()

Símbolo	Marcación	Puntos	Equivale	Inmovilización
○	IPPON	10	HANSOKU MAKE	25 seg.
⊖	WAZARI	7	3er SHIDO	de 20 a -25 seg.
⊗	YUKO	5	2do SHIDO	de 15 a -20 seg.
⊕	KOKA	3	1er SHIDO	de 10 a -15 seg.
⊗	HANTEI	1		



CONFEDERACION SURAMERICANA DE JUDO

CONFEDERACION ARGENTINA DE JUDO



Evento **CAMP. SURAMERICANO JUVENIL Y JUNIOR**

Lugar **BUENOS AIRES ARGENTINA** **Fecha** **10/09/2004** **al** **12/09/2004**

Categoría **Junior** **Peso** **-100** **kgs.** **Sexo** **Masculino**

Eliminatoria Round Robin (Todos contra todos)

Nº	Nombre	País	1	2	3	4	5	Vict.	Ptos.	Lugar
1	OLIVEIRA Luis	BRA		7	0			1	7	2
2	AMEZQUITA Luis	VEN	0		0			0	0	3
3	CISNEROS German	ARG	10	5				2	15	1
4	--	-								
5	--	-								

Pool de: _____

Orden de los Combates		
1-2	1-2	1-2
2-3	3-4	3-4
1-3	1-3	1-5
	2-4	2-3
	1-4	4-5
	2-3	1-3
		2-5
		1-4
		3-5
		2-4

- 1º _____ (ARG)
- 2º _____ (BRA)
- 3º _____ (VEN)
- 3º _____ ()
- 5º _____ ()

Símbolo	Marcación	Puntos	Equivale	Inmovilización
○	IPPON	10	HANSOKU MAKE	25 seg.
⊖	WAZARI	7	3er SHIDO	de 20 a -25 seg.
⊗	YUKO	5	2do SHIDO	de 15 a -20 seg.
⊕	KOKA	3	1er SHIDO	de 10 a -15 seg.
⊗	HANTEI	1		