











Evento **CAMP. SURAMERICANO JUVENIL Y JUNIOR**
 Lugar **BUENOS AIRES ARGENTINA** Fecha **10/09/2004** al **12/09/2004**
 Place _____ Date _____ to _____

Cuadro de Medallas / Table of Medals







Categoría
Category **Juvenil General**

Posición Position	País Country	Oro 1st	Plata 2nd	Bronce 3rd	Total
1	BRA 	6	4	5	15
2	ARG 	3	5	3	11
3	VEN 	3	2	4	9
4	ECU 	2	1	0	3
5	URU 	1	2	2	5
6	CHI 	0	1	2	3
7	PER 	0	0	1	1
8	COL 	0	0	1	1
9	PAR 	0	0	0	0
10	BOL 	0	0	0	0
Total		15	15	18	48

Evento **CAMP. SURAMERICANO JUVENIL Y JUNIOR**
 Lugar **BUENOS AIRES ARGENTINA** Fecha **10/09/2004** al **12/09/2004**
 Place

Cuadro de Medallas / Table of Medals











Categoría
Category **Juvenil Fem**

Posición Position	País Country	Oro 1st	Plata 2nd	Bronce 3rd	Total
1	BRA 	3	2	2	7
2	VEN 	3	0	2	5
3	ARG 	1	3	1	5
4	ECU 	1	0	0	1
5	URU 	0	1	2	3
6	CHI 	0	1	0	1
7	BOL 	0	0	0	0
Total		8	7	7	22

Evento **CAMP. SURAMERICANO JUVENIL Y JUNIOR**
 Lugar **BUENOS AIRES ARGENTINA** Fecha **10/09/2004** al **12/09/2004**
 Place

Cuadro de Medallas / Table of Medals

Categoría
Category **Juvenil Masc**

Posición Position	País Country	Oro 1st	Plata 2nd	Bronce 3rd	Total
1	BRA 	3	2	3	8
2	ARG 	2	2	2	6
3	URU 	1	1	0	2
4	ECU 	1	1	0	2
5	VEN 	0	2	2	4
6	CHI 	0	0	2	2
7	PER 	0	0	1	1
8	COL 	0	0	1	1
9	PAR 	0	0	0	0
10	BOL 	0	0	0	0
Total		7	8	11	26



CONFEDERACION SURAMERICANA DE JUDO

CONFEDERACION ARGENTINA DE JUDO



Evento **Event** **CAMP. SURAMERICANO JUVENIL Y JUNIOR**

Lugar **Place** **BUENOS AIRES ARGENTINA** **Fecha** **Date** **10/09/2004** **al** **to** **12/09/2004**

Categoría **Category** **Juvenil** **Peso** **Weight** **-81** **kgs.** **Sexo** **Gender** **Masculino**

Eliminatoria Round Robin (Todos contra todos)

Nº	Nombre	País	1	2	3	4	5	Vict.	Ptos.	Lugar
1	SANTOS Ramón	BRA		0	0			0	0	3
2	ZULKOVSKI Rodrigo	ARG	7		0			1	7	2
3	BOUZA Guillermo	URU	10	10				2	10	1
4	--	-								
5	--	-								

Pool de: _____

Orden de los Combates		
1-2	1-2	1-2
2-3	3-4	3-4
1-3	1-3	1-5
	2-4	2-3
	1-4	4-5
	2-3	1-3
		2-5
		1-4
		3-5
		2-4

- 1º _____ (URU)
- 2º _____ (ARG)
- 3º _____ (BRA)
- 3º _____ ()
- 5º _____ ()

Símbolo	Marcación	Puntos	Equivale	Inmovilización
○	IPPON	10	HANSOKU MAKE	25 seg.
⊖	WAZARI	7	3er SHIDO	de 20 a -25 seg.
⊗	YUKO	5	2do SHIDO	de 15 a -20 seg.
⊕	KOKA	3	1er SHIDO	de 10 a -15 seg.
⊗	HANTEI	1		



CONFEDERACION SURAMERICANA DE JUDO

CONFEDERACION ARGENTINA DE JUDO



Evento **Event** **CAMP. SURAMERICANO JUVENIL Y JUNIOR**

Lugar **Place** **BUENOS AIRES ARGENTINA** **Fecha** **Date** **10/09/2004** **al** **to** **12/09/2004**

Categoría **Category** **Juvenil** **Peso** **Weight** **-73** **kgs.** **Sexo** **Gender** **Masculino**

Eliminatoria Round Robin (Todos contra todos)

Nº	Nombre	País	1	2	3	4	5	Vict.	Ptos.	Lugar
1	SORIA José	ARG		0	5	0		1	5	4
2	APRAHAMIAN Mikael	URU	10		0	0		1	10	2
3	TORRES Ivan	VEN	0	7		0		1	7	3
4	RAMOS Rafael	BRA	10	10	3			3	23	1
5	--	-								

Pool de: _____

Orden de los Combates		
1-2	1-2	1-2
2-3	3-4	3-4
1-3	1-3	1-5
	2-4	2-3
	1-4	4-5
	2-3	1-3
		2-5
		1-4
		3-5
		2-4

- 1º _____ (BRA)
- 2º _____ (URU)
- 3º _____ (VEN)
- 3º _____ (ARG)
- 5º _____ ()

Símbolo	Marcación	Puntos	Equivale	Inmovilización
○	IPPON	10	HANSOKU MAKE	25 seg.
⊖	WAZARI	7	3er SHIDO	de 20 a -25 seg.
⊗	YUKO	5	2do SHIDO	de 15 a -20 seg.
⊕	KOKA	3	1er SHIDO	de 10 a -15 seg.
⊗	HANTEI	1		



CONFEDERACION SURAMERICANA DE JUDO

CONFEDERACION ARGENTINA DE JUDO



Evento **CAMP. SURAMERICANO JUVENIL Y JUNIOR**

Lugar **BUENOS AIRES ARGENTINA** **Fecha** **10/09/2004** **al** **12/09/2004**

Categoría **Juvenil** **Peso** **-70** **kgs.** **Sexo** **Femenino**

Eliminatoria Round Robin (Todos contra todos)

Nº	Nombre	País	1	2	3	4	5	Vict.	Ptos.	Lugar
1	CONCEICAO Priscila	BRA		0	-			0	0	3
2	ROJAS María	VEN	10		10			2	20	1
3	CORTEZ Jaqueline	ARG	10	0				1	10	2
4	--	-								
5	--	-								

Pool de: _____

Orden de los Combates		
1-2	1-2	1-2
2-3	3-4	3-4
1-3	1-3	1-5
	2-4	2-3
	1-4	4-5
	2-3	1-3
		2-5
		1-4
		3-5
		2-4

- 1º _____ (VEN)
- 2º _____ (ARG)
- 3º _____ (BRA)
- 3º _____ ()
- 5º _____ ()

Símbolo	Marcación	Puntos	Equivale	Inmovilización
○	IPPON	10	HANSOKU MAKE	25 seg.
◐	WAZARI	7	3er SHIDO	de 20 a -25 seg.
◑	YUKO	5	2do SHIDO	de 15 a -20 seg.
◒	KOKA	3	1er SHIDO	de 10 a -15 seg.
⊗	HANTEI	1		



CONFEDERACION SURAMERICANA DE JUDO

CONFEDERACION ARGENTINA DE JUDO



Evento / Event: **CAMP. SURAMERICANO JUVENIL Y JUNIOR**
Lugar / Place: **BUENOS AIRES ARGENTINA** **Fecha / Date:** **10/09/2004** **al / to:** **12/09/2004**
Categoría / Category: **Juvenil** **Peso / Weight:** **-66** **kgs. / Gender:** **Masculino**

Repechage Doble Cruzado para 8 Competidores

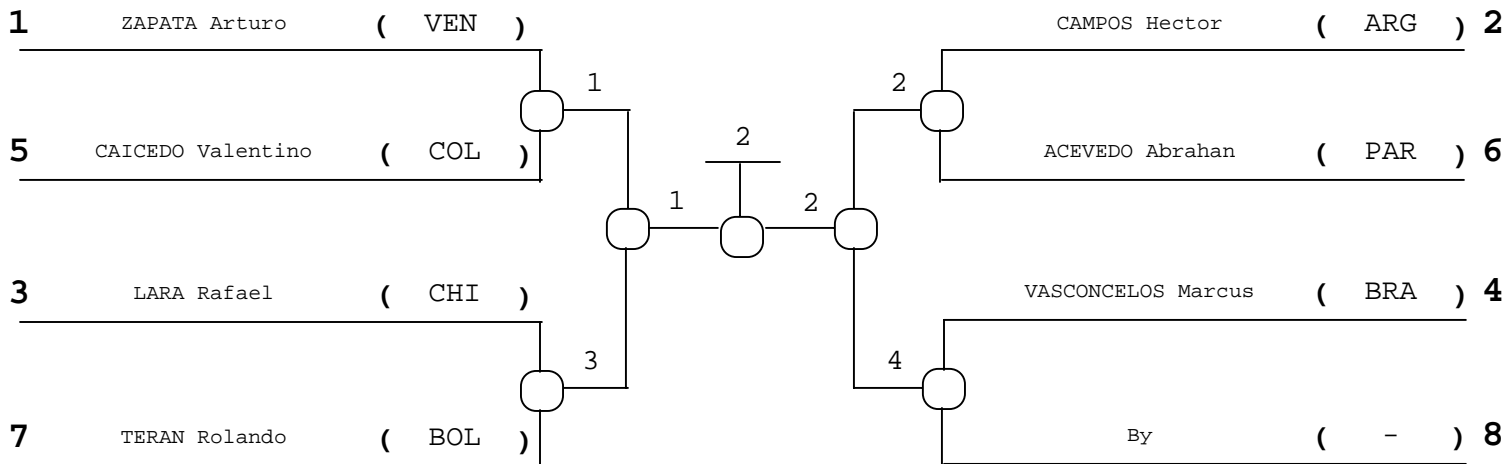

Repechage "A"

Repechage "B"

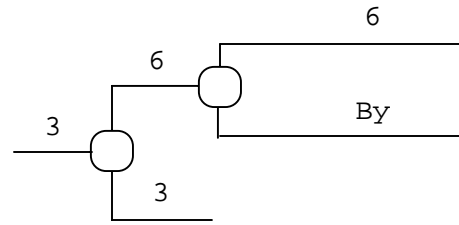
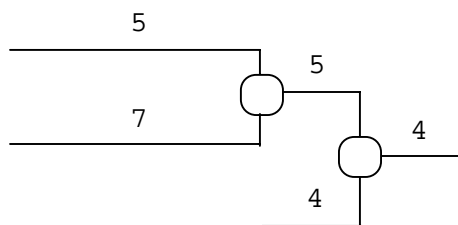

- | | | |
|----|--------------------|---------|
| 1º | CAMPOS Hector | (ARG) |
| 2º | ZAPATA Arturo | (VEN) |
| 3º | VASCONCELOS Marcus | (BRA) |
| 3º | LARA Rafael | (CHI) |
| 5º | CAICEDO Valentino | (COL) |
| 5º | ACEVEDO Abrahan | (PAR) |



CONFEDERACION SURAMERICANA DE JUDO
CONFEDERACION ARGENTINA DE JUDO



Evento **CAMP. SURAMERICANO JUVENIL Y JUNIOR**
Lugar **BUENOS AIRES ARGENTINA** **Fecha** **10/09/2004** **al** **12/09/2004**
Place **BUENOS AIRES ARGENTINA** **Date** **10/09/2004** **to** **12/09/2004**
Categoría **Juvenil** **Peso** **-63** **kgs.** **Sexo** **Femenino**
Category **Juvenil** **Weight** **-63** **kgs.** **Gender** **Femenino**

Eliminatoria Round Robin (Todos contra todos)

Nº	Nombre	País	1	2	3	4	5	Vict.	Ptos.	Lugar
1	GALLEGOS Daniela	CHI	0	0	0	0	0	0	0	4
2	CAPO Daniela	ARG	10	0	0	0	0	1	10	3
3	DUARTE Narbelis	VEN	10	7	3	3	0	3	20	1
4	SANTOS Haysa	BRA	10	10	0	0	0	2	20	2
5	--	-								

Pool de: _____

Orden de los Combates		
1-2	1-2	1-2
2-3	3-4	3-4
1-3	1-3	1-5
	2-4	2-3
	1-4	4-5
	2-3	1-3
		2-5
		1-4
		3-5
		2-4

- 1º _____ (VEN)
 2º _____ (BRA)
 3º _____ (ARG)
 3º _____ (CHI)
 5º _____ ()

Símbolo	Marcación	Puntos	Equivale	Inmovilización
○	IPPON	10	HANSOKU MAKE	25 seg.
⊖	WAZARI	7	3er SHIDO	de 20 a -25 seg.
⊗	YUKO	5	2do SHIDO	de 15 a -20 seg.
⊕	KOKA	3	1er SHIDO	de 10 a -15 seg.
⊗	HANTEI	1		



CONFEDERACION SURAMERICANA DE JUDO

CONFEDERACION ARGENTINA DE JUDO



Evento / Event: **CAMP. SURAMERICANO JUVENIL Y JUNIOR**
Lugar / Place: **BUENOS AIRES ARGENTINA** **Fecha / Date:** **10/09/2004** **al / to:** **12/09/2004**
Categoría / Category: **Juvenil** **Peso / Weight:** **-60** **kgs. / Gender:** **Masculino**

Repechage Doble Cruzado para 8 Competidores

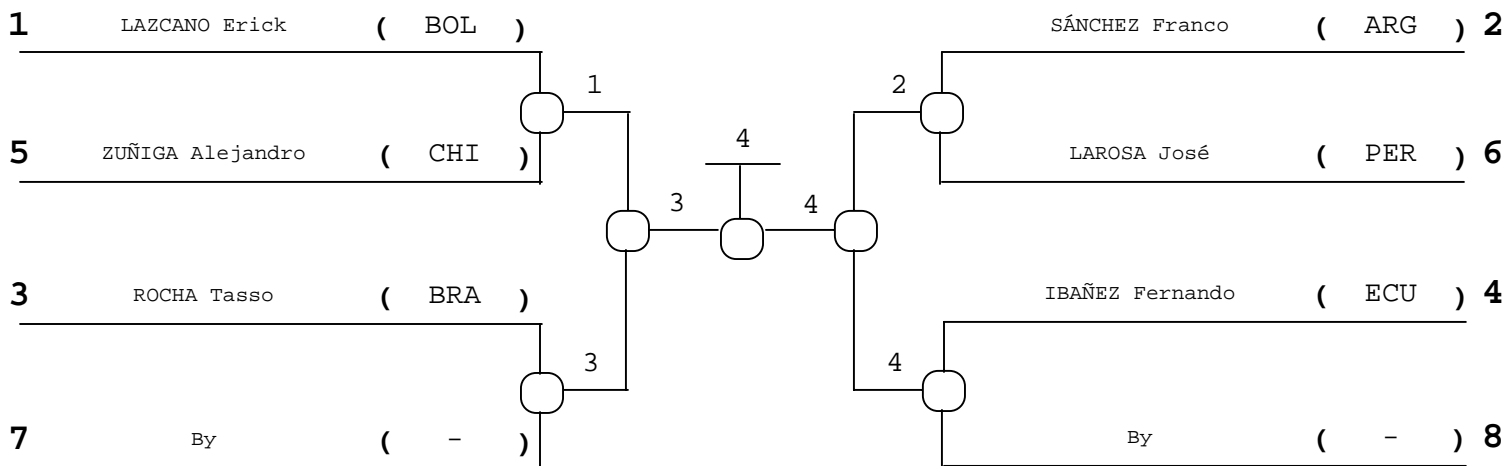

Repechage "A"

Repechage "B"

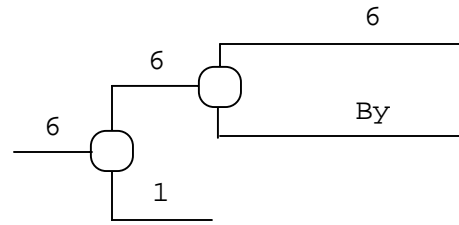
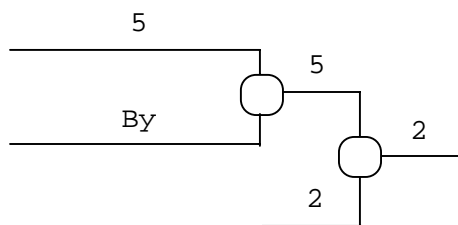

- | | | |
|----|------------------|---------|
| 1º | IBAÑEZ Fernando | (ECU) |
| 2º | ROCHA Tasso | (BRA) |
| 3º | SÁNCHEZ Franco | (ARG) |
| 3º | LAROSA José | (PER) |
| 5º | ZUÑIGA Alejandro | (CHI) |
| 5º | LAZCANO Erick | (BOL) |



CONFEDERACION SURAMERICANA DE JUDO

CONFEDERACION ARGENTINA DE JUDO



Evento **CAMP. SURAMERICANO JUVENIL Y JUNIOR**
Event
Lugar **BUENOS AIRES ARGENTINA** **Fecha** **10/09/2004** **al** **12/09/2004**
Place **Date** **to**
Categoría **Juvenil** **Peso** **-57** **kgs.** **Sexo** **Femenino**
Category **Weight** **Gender**

Repechage Doble Cruzado para 8 Competidores

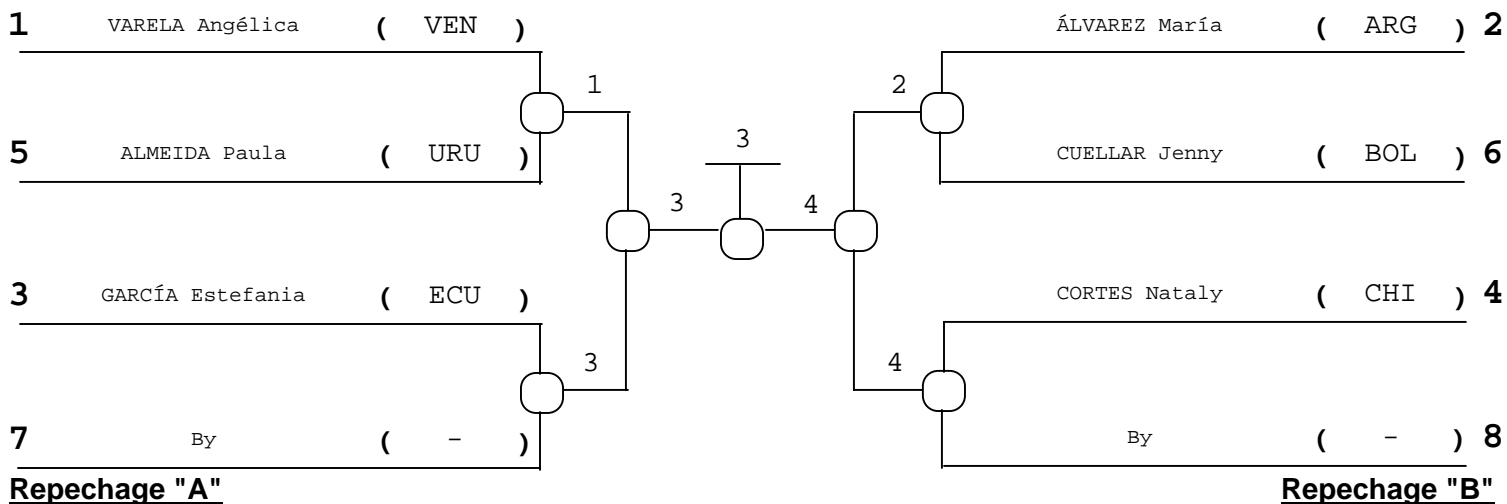

Repechage "A"

Repechage "B"

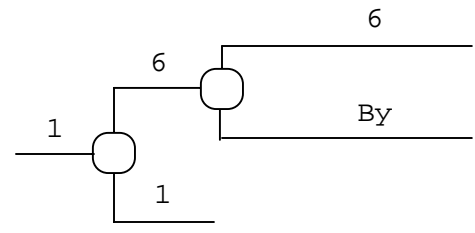
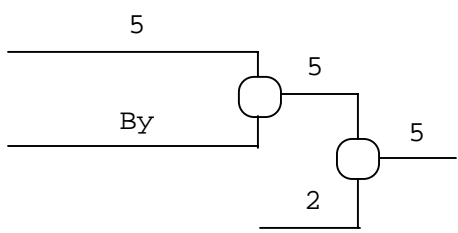

- 1º GARCÍA Estefania (ECU)
- 2º CORTES Nataly (CHI)
- 3º ALMEIDA Paula (URU)
- 3º VARELA Angélica (VEN)
- 5º ÁLVAREZ María (ARG)
- 5º CUELLAR Jenny (BOL)



CONFEDERACION SURAMERICANA DE JUDO

CONFEDERACION ARGENTINA DE JUDO



Evento **CAMP. SURAMERICANO JUVENIL Y JUNIOR**
Event
Lugar **BUENOS AIRES ARGENTINA** **Fecha** **10/09/2004** **al** **12/09/2004**
Place **Date** **to**
Categoría **Juvenil** **Peso** **-55** **kgs.** **Sexo** **Masculino**
Category **Weight** **Gender**

Repechage Doble Cruzado para 8 Competidores

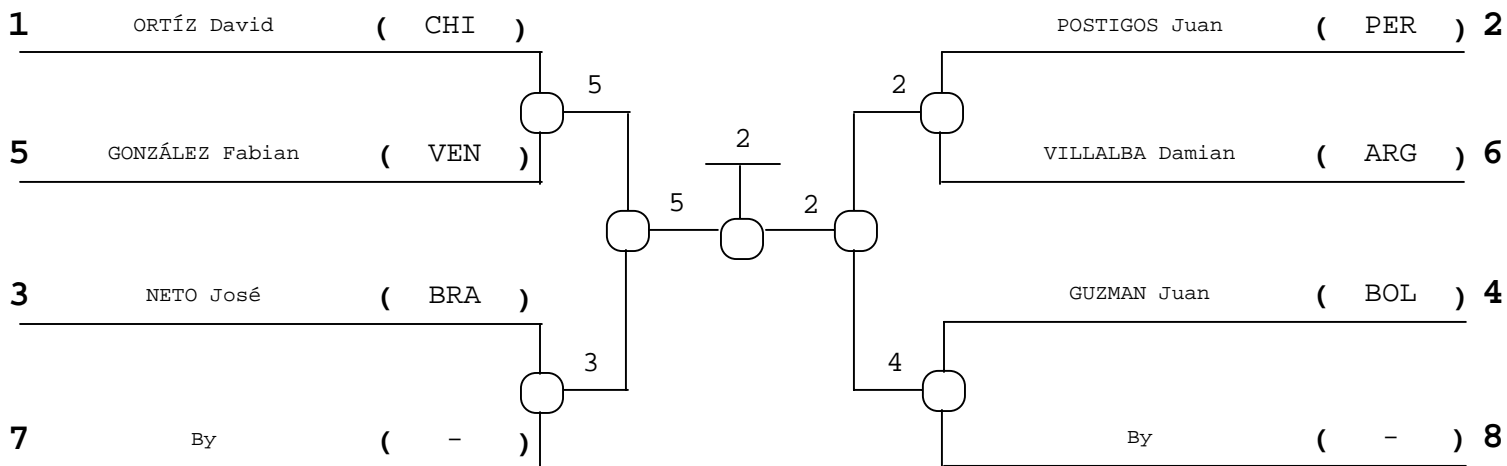

Repechage "A"

Repechage "B"

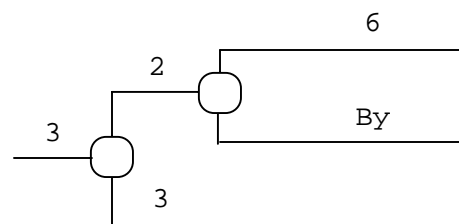
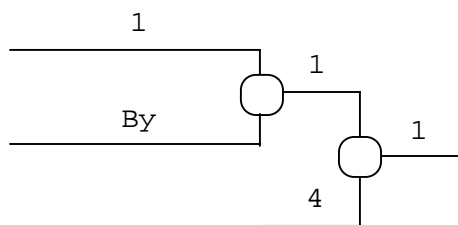

- 1º POSTIGOS Juan (PER)
- 2º GONZÁLEZ Fabian (VEN)
- 3º ORTÍZ David (CHI)
- 3º NETO José (BRA)
- 5º GUZMAN Juan (BOL)
- 5º POSTIGOS Juan (PER)



CONFEDERACION SURAMERICANA DE JUDO

CONFEDERACION ARGENTINA DE JUDO



Evento **Event** **CAMP. SURAMERICANO JUVENIL Y JUNIOR**

Lugar **Place** **BUENOS AIRES ARGENTINA** **Fecha** **Date** **10/09/2004** **al** **to** **12/09/2004**

Categoría **Category** **Juvenil** **Peso** **Weight** **-52** **kgs.** **Sexo** **Gender** **Femenino**

Eliminatoria Round Robin (Todos contra todos)

Nº	Nombre	País	1	2	3	4	5	Vict.	Ptos.	Lugar
1	ROMERO Cecilia	URU		0	10			1	10	2
2	BIELAKOWICZ Lariza	ARG	10		10			2	20	1
3	SILVA Samia	BRA	0	0				0	0	3
4	--	-								
5	--	-								

Pool de: _____

Orden de los Combates		
1-2	1-2	1-2
2-3	3-4	3-4
1-3	1-3	1-5
	2-4	2-3
	1-4	4-5
	2-3	1-3
		2-5
		1-4
		3-5
		2-4

- 1º _____ (ARG)
- 2º _____ (URU)
- 3º _____ (BRA)
- 3º _____ ()
- 5º _____ ()

Símbolo	Marcación	Puntos	Equivale	Inmovilización
○	IPPON	10	HANSOKU MAKE	25 seg.
⊖	WAZARI	7	3er SHIDO	de 20 a -25 seg.
⊗	YUKO	5	2do SHIDO	de 15 a -20 seg.
⊕	KOKA	3	1er SHIDO	de 10 a -15 seg.
⊗	HANTEI	1		



CONFEDERACION SURAMERICANA DE JUDO

CONFEDERACION ARGENTINA DE JUDO



Evento **CAMP. SURAMERICANO JUVENIL Y JUNIOR**

Lugar **BUENOS AIRES ARGENTINA** **Fecha** **10/09/2004** **al** **12/09/2004**

Categoría **Juvenil** **Peso** **-51** **kgs.** **Sexo** **Masculino**

Eliminatoria Round Robin (Todos contra todos)

Nº	Nombre	País	1	2	3	4	5	Vict.	Ptos.	Lugar
1	PRADO Martín	ECU		10	0	10	7	3	27	2
2	BOLLEA Emanuel	ARG	0		0	10	10	2	20	3
3	AZEVEDO Samuel	BRA	10	7		5	5	4	27	1
4	IDRO Rodrigo	CHI	0	0	0		5	1	5	4
5	BARONA Wilson	COL	0	0	0	0		0	0	5

Pool de: _____

Orden de los Combates		
1-2	1-2	1-2
2-3	3-4	3-4
1-3	1-3	1-5
	2-4	2-3
	1-4	4-5
	2-3	1-3
		2-5
		1-4
		3-5
		2-4

- 1º _____ AZEVEDO Samuel (BRA)
- 2º _____ PRADO Martín (ECU)
- 3º _____ BOLLEA Emanuel (ARG)
- 3º _____ IDRO Rodrigo (CHI)
- 5º _____ BARONA Wilson (COL)

Símbolo	Marcación	Puntos	Equivale	Inmovilización
○	IPPON	10	HANSOKU MAKE	25 seg.
⊖	WAZARI	7	3er SHIDO	de 20 a -25 seg.
⊗	YUKO	5	2do SHIDO	de 15 a -20 seg.
⊕	KOKA	3	1er SHIDO	de 10 a -15 seg.
⊗	HANTEI	1		



CONFEDERACION SURAMERICANA DE JUDO

CONFEDERACION ARGENTINA DE JUDO



Evento **Event** **CAMP. SURAMERICANO JUVENIL Y JUNIOR**

Lugar **Place** **BUENOS AIRES ARGENTINA** **Fecha** **Date** **10/09/2004** **al** **to** **12/09/2004**

Categoría **Category** **Juvenil** **Peso** **Weight** **-48** **kgs.** **Sexo** **Gender** **Femenino**

Eliminatoria Round Robin (Todos contra todos)

Nº	Nombre	País	1	2	3	4	5	Vict.	Ptos.	Lugar
1	CHAVEZ Gracie	BRA		7	10	10	10	4	37	1
2	PANTANO Lucia	ARG	0		10	10	10	3	30	2
3	HIROMITONE Alessandra	URU	0	0		5	10	2	15	3
4	HERNÁNDEZ Claudia	CHI	0	0	0		5	1	5	4
5	DURAN Andrea	VEN	0	0	0	0		0	0	5

Pool de: _____

Orden de los Combates		
1-2	1-2	1-2
2-3	3-4	3-4
1-3	1-3	1-5
	2-4	2-3
	1-4	4-5
	2-3	1-3
		2-5
		1-4
		3-5
		2-4

- 1º _____ (BRA)
- 2º _____ (ARG)
- 3º _____ (URU)
- 3º _____ (CHI)
- 5º _____ (VEN)

Símbolo	Marcación	Puntos	Equivale	Inmovilización
○	IPPON	10	HANSOKU MAKE	25 seg.
⊖	WAZARI	7	3er SHIDO	de 20 a -25 seg.
⊗	YUKO	5	2do SHIDO	de 15 a -20 seg.
⊕	KOKA	3	1er SHIDO	de 10 a -15 seg.
⊗	HANTEI	1		



CONFEDERACION SURAMERICANA DE JUDO

CONFEDERACION ARGENTINA DE JUDO



Evento **Event** **CAMP. SURAMERICANO JUVENIL Y JUNIOR**

Lugar **Place** **BUENOS AIRES ARGENTINA** **Fecha** **Date** **10/09/2004** **al** **to** **12/09/2004**

Categoría **Category** **Juvenil** **Peso** **Weight** **-44** **kgs.** **Sexo** **Gender** **Femenino**

Eliminatoria Round Robin (Todos contra todos)

Nº	Nombre	País	1	2	3	4	5	Vict.	Ptos.	Lugar
1	BARRIOS Laisa	BRA		10	10			2	20	1
2	MEDRANO Yulieth	VEN	0		0			0	0	3
3	BONDI BMaría	ARG	0	5				1	5	2
4	--	-								
5	--	-								

Pool de: _____

Orden de los Combates		
1-2	1-2	1-2
2-3	3-4	3-4
1-3	1-3	1-5
	2-4	2-3
	1-4	4-5
	2-3	1-3
		2-5
		1-4
		3-5
		2-4

- 1º _____ (BRA)
- 2º _____ (ARG)
- 3º _____ (VEN)
- 3º _____ ()
- 5º _____ ()

Símbolo	Marcación	Puntos	Equivale	Inmovilización
○	IPPON	10	HANSOKU MAKE	25 seg.
⊖	WAZARI	7	3er SHIDO	de 20 a -25 seg.
⊗	YUKO	5	2do SHIDO	de 15 a -20 seg.
⊕	KOKA	3	1er SHIDO	de 10 a -15 seg.
⊗	HANTEI	1		



CONFEDERACION SURAMERICANA DE JUDO

CONFEDERACION ARGENTINA DE JUDO



Evento **Event** **CAMP. SURAMERICANO JUVENIL Y JUNIOR**

Lugar **Place** **BUENOS AIRES ARGENTINA** **Fecha** **Date** **10/09/2004** **al** **to** **12/09/2004**

Categoría **Category** **Juvenil** **Peso** **Weight** **-40** **kgs.** **Sexo** **Gender** **Femenino**

Eliminatoria Round Robin (Todos contra todos)

Nº	Nombre	País	1	2	3	4	5	Vict.	Ptos.	Lugar
1	URBANO Heccsis	VEN		7	7			2	14	1
2	OLIVEIRA Ana	BRA	0		0			0	0	2
3	--	-								
4	--	-								
5	--	-								

Pool de: _____

Orden de los Combates		
1-2	1-2	1-2
2-3	3-4	3-4
1-3	1-3	1-5
	2-4	2-3
	1-4	4-5
	2-3	1-3
		2-5
		1-4
		3-5
		2-4

- 1º _____ (VEN)
- 2º _____ (BRA)
- 3º _____ ()
- 3º _____ ()
- 5º _____ ()

Símbolo	Marcación	Puntos	Equivale	Inmovilización
○	IPPON	10	HANSOKU MAKE	25 seg.
⊖	WAZARI	7	3er SHIDO	de 20 a -25 seg.
⊗	YUKO	5	2do SHIDO	de 15 a -20 seg.
⊕	KOKA	3	1er SHIDO	de 10 a -15 seg.
⊗	HANTEI	1		



CONFEDERACION SURAMERICANA DE JUDO

CONFEDERACION ARGENTINA DE JUDO



Evento **CAMP. SURAMERICANO JUVENIL Y JUNIOR**
Event **CAMP. SURAMERICANO JUVENIL Y JUNIOR**

Lugar **BUENOS AIRES ARGENTINA** **Fecha** **10/09/2004** **al** **12/09/2004**
Place **BUENOS AIRES ARGENTINA** **Date** **10/09/2004** **to** **12/09/2004**

Categoría **Juvenil** **Peso** **+90** **kgs.** **Sexo** **Masculino**
Category **Juvenil** **Weight** **+90** **kgs.** **Gender** **Masculino**

Eliminatoria Round Robin (Todos contra todos)

Nº	Nombre	País	1	2	3	4	5	Vict.	Ptos.	Lugar
1	DEPETRIS Daniel	ARG		0	10			1	10	2
2	OLIVEIRA Paulo	BRA	10		10			2	20	1
3	GONZÁLEZ Harold	COL	0	0				0	0	3
4	--	-								
5	--	-								

Pool de: _____

Orden de los Combates		
1-2	1-2	1-2
2-3	3-4	3-4
1-3	1-3	1-5
	2-4	2-3
	1-4	4-5
	2-3	1-3
		2-5
		1-4
		3-5
		2-4

- 1º _____ (BRA)
 OLIVEIRA Paulo
- 2º _____ (ARG)
 DEPETRIS Daniel
- 3º _____ (COL)
 GONZÁLEZ Harold
- 3º _____ ()
- 5º _____ ()

Símbolo	Marcación	Puntos	Equivale	Inmovilización
○	IPPON	10	HANSOKU MAKE	25 seg.
◐	WAZARI	7	3er SHIDO	de 20 a -25 seg.
◑	YUKO	5	2do SHIDO	de 15 a -20 seg.
◒	KOKA	3	1er SHIDO	de 10 a -15 seg.
⊗	HANTEI	1		



CONFEDERACION SURAMERICANA DE JUDO

CONFEDERACION ARGENTINA DE JUDO



Evento
Event **CAMP. SURAMERICANO JUVENIL Y JUNIOR**

Lugar
Place **BUENOS AIRES ARGENTINA** **Fecha**
Date **10/09/2004** **al**
to **12/09/2004**

Categoría
Category **Juvenil** **Peso**
Weight **-90** **kgs.** **Sexo**
Gender **Masculino**

Eliminatoria Round Robin (Todos contra todos)

Nº	Nombre	País	1	2	3	4	5	Vict.	Ptos.	Lugar
1	TIMAURE Isaac	VEN		5	0	5		2	10	3
2	BRIT Ernesto	ARG	0		10	10		2	20	1
3	COUTINHO Hugo	BRA	10	0		10		2	20	2
4	GALAZ Sebastian	CHI	0	0	0			0	0	4
5	--	-								

Pool de: _____

Orden de los Combates		
1-2	1-2	1-2
2-3	3-4	3-4
1-3	1-3	1-5
	2-4	2-3
	1-4	4-5
	2-3	1-3
		2-5
		1-4
		3-5
		2-4

- 1º _____ (ARG)
- 2º _____ (BRA)
- 3º _____ (VEN)
- 3º _____ (CHI)
- 5º _____ ()

Símbolo	Marcación	Puntos	Equivale	Inmovilización
○	IPPON	10	HANSOKU MAKE	25 seg.
⊖	WAZARI	7	3er SHIDO	de 20 a -25 seg.
⊗	YUKO	5	2do SHIDO	de 15 a -20 seg.
⊕	KOKA	3	1er SHIDO	de 10 a -15 seg.
⊗	HANTEI	1		